

Secretariat of the Pacific Community

Port Sampling Manual



Oceanic Fisheries Programme



Port Sampling Manual

by Deirdre Brogan
Oceanic Fisheries Programme



SECRETARIAT OF THE PACIFIC COMMUNITY

© Copyright Secretariat of the Pacific Community, 2002

All rights for commercial / for profit reproduction or translation, in any form, reserved. The SPC authorises the partial reproduction or translation of this material for scientific, educational or research purposes, provided that SPC and the source document are properly acknowledged. Permission to reproduce the document and/or translate in whole, in any form, whether for commercial / for profit or non-profit purposes, must be requested in writing. Original SPC artwork may not be altered or separately published without permission.

Original text: English

Secretariat of the Pacific Community Cataloguing-in-publication data

Port sampling manual / by Deirdre Brogan

1. Fisheries–Sampling (Statistics)–Handbooks, manuals, etc.
 2. Fish–Sampling
- I. Title II. Secretariat of the Pacific Community

639.2

AACR2

ISBN 982-203-887-9

Secretariat of the Pacific Community
BP D5
98848 Noumea Cedex
New Caledonia
Tel: +687 20.20.00
Fax: +687 26.38.18
E-mail: spc@spc.int

Funded by Global Environment Facility (GEF)

Layout : Muriel Borderie; Cover and illustrations: Jipé Le-Bars;
Editors: Kim Des Rochers and Sarah Langi
Prepared for publication and printed at
Secretariat of the Pacific Community headquarters
Noumea, New Caledonia, 2002



Contents

1. <i>Introduction</i>	1
2. <i>Why We Collect Data</i>	2
• Regional data collection forms	2
• Logsheet data	3
• Unloading data	3
• Observer data	3
• What will port sampling data tell us?	3
• How your port sampling data are used	5
• Length-frequency graphs	5
• Length-frequency graphs from port sampling data	6
3. <i>The Basics</i>	7
• Be prepared!	7
• Be organised!	7
• Be diplomatic!	8
• Be smart!	9
• Recording vessel details	10
• Recording the length measurements	14
• Regional standard length measurements	17
• Recording the weight measurements	26
4. <i>Port Sampling for Purse-seine Vessels</i>	27
• How to choose an appropriate well for purse-seine sampling	28
• Choices	37
• Sampling methods	40
• The practicalities of sampling	43
5. <i>Port Sampling Pole-and-line Vessels</i>	45
• How to carry out pole-and-line port sampling	45
6. <i>Port Sampling Longline Vessels</i>	47
• Sampling protocols	47
• Completing the form	49
• Species identification for longline port sampling	51

7. <i>Other Things To Consider</i>53
• Recovering tags53
• Monthly report55
• Reporting pollution55
• Falsifying data55
8. <i>Reference Materials</i>56
• Online resources56
• References56
• Port sampling harbours57
• A few words in another language58
• Species identification sheets59
• How to avoid common errors on longline sampling forms62
• How to avoid common errors on purse-seine sampling forms63
• A step-by-step guide to selecting wells for purse-seine port sampling64
9. <i>The Regional Data Collection Forms</i>67



Introduction

***A* lii, Bonjour, Bula, Fakaalofa atu, Hello, Halo, Iaora, Kia orana, Namō, Malo e lelei, Malo to mauli, Talofa, Yokwe !**

Measuring fish is an important job. It is also a rewarding job. The work a port sampler does directly contributes to the conservation of one of the world's last sustainable fisheries — the tuna fishery of the western and central Pacific. It may not look like a difficult job. You may even be surprised to learn there is a resource manual prepared for such a task, but while measuring fish is fundamental to the job, the port sampler has other roles to fill. Diplomat, statistician and biologist are all roles that the port sampler must comfortably play.

This manual is aimed at Pacific Island port samplers who often work in an isolated and independent manner. Fishery headquarters can be across the water or even a plane ride away. There are also the quieter periods to consider. Licensing agreements, seasons, and inter-annual climactic variations may contribute to long intervals between sampling times. With the aid of this manual, port samplers who can sharpen and refresh their skills as required. To ensure good data quality, SPC prefers to use port samplers who have passed a Regional Observers Training Course, but sometimes that is not possible. Where no trained observers are available, due to staff turnovers or an unprecedented busy period, and with the prior consent of SPC, this manual can also aid with the on-site training of assistant port samplers.

A fishing harbour can be a magical place. The fishers are often relaxed and happy, proud of their catch. The days when big fish, or even a new type of fish, are landed are memorable ones, and there are always a few fishing tales to be heard. We imagine port samplers will enjoy being part of such a vibrant community; proud to contribute to the management of the tuna fishery stock and keen to and help sustain the stock for future generations.

Acknowledgements

The production of this manual would not have been possible without the support of my colleagues. I am especially grateful to Tim Lawson and Peter Williams for their input and guidance. I would also like to acknowledge the work done by previous staff members, in developing and maintaining port sampling work over the years - the most recent of whom was Peter Sharples.

Chapter 2: Why we collect data

The Pacific Ocean is vast and the number of tuna it contains immense. In fact, the western and central Pacific presently supports the largest industrialised tuna fishery in the world. During the 1990s, an average of one-and-a-half million metric tons of tuna were taken from the Pacific Ocean each year. Apparently we can catch a lot of tuna, without endangering the stock. But how much is a lot? Could we take more? Should we be taking less? These are the questions that fishery scientists endeavour to answer.

The actual number of tuna in the ocean is always changing. Fish are constantly being captured, and tuna can spawn almost daily at the equator. Some factors that affect the tuna stock are: the number of vessels fishing, how many fish they catch, the number of fish produced by spawning, and the number lost through natural mortality. Fishery scientists predict how much tuna is in the Pacific Ocean by analysing data from many different sources. Port samplers are directly involved in the collection of some of that data.

Regional data collection forms

To ensure that data are accurate and comparable, standardised data sheets are used. These include: logsheets, unloading forms, port sampling and observer data forms. The format and content of the forms are reviewed at the end of every second year (in December), by the Data Collection Committee and revised when required. The Committee is made up of staff

from SPC, the Forum Fisheries Agency (FFA), and other invited guests. The year of revision is placed at the top lefthand corner of each data sheet. Port samplers need to be aware of these revisions and always use the most up-to-date forms. Only the most current data forms should be kept in circulation. Out-of-date forms should be discarded.

Up-to-date data forms are available on SPC's website: <http://www.spc.int/oceanfish/>. Chapter nine gives an example of such forms (current at the time of publication).

The following is an overview of the use and purpose of the regional standard data collection forms.

Port samplers are encouraged to know who is responsible for collecting each of the regional standard data collection forms from all the vessels that visit their harbours and to help with the collection of these forms where necessary.



Logsheet data

Logsheets record the fishing activity, the catch (by species), and other information including: the start of the operation, gear details and the fishing position. Logsheet data are used by scientists in stock assessment analyses. They are valuable because they state exactly where and when the catch was taken. This is not the case with port sampling or unloading data. Observer data do tell us when and where the catch was taken but the number of trips actually covered by observers is low, while logsheet data are generally available for most trips. Translated logsheets (Japanese, Mandarin, and Korean) are available on the SPC website.

Unloading data

Unloading data are collected by the port samplers or fishery officers at ports where vessels transfer their catch, typically to carrier vessels, air transport, canneries, or other receivers. Unloading data provide the estimated total unloaded weight of the catch by species from a vessel trip. This information is usually estimated by the agents involved in the transferring or receiving process. The fishing vessel does not normally provide it.

Unloading data provide an independent estimate of the trip catch, which can be used to verify the logsheet data. They are also important in that they can provide catch totals for vessels that do not provide logsheets (i.e. some domestic vessels).

Unloading data are used in the estimation of total catch by a fleet over a period of time. As unloaded catch data do not tell us when and where the catch was taken, they are not usually suitable for research analyses.

Port sampling data

Length and species composition data are fundamental to the stock assessment work conducted by scientists. Port sampling offers the most convenient and cost-effective method to obtain considerable quantities of these data (compared with observer data, for instance). Unlike logsheet and unloading data, there is no need to collect port sampling data from every single vessel fishing in the region.

Observer data

Observer data are the best monitoring data. Not only do they record when, where, and how much fish were caught, they also record the fishing effort, vessel and by-catch details. Unfortunately, observer coverage is presently very low and observer data is relatively expensive and time consuming to collect.

What will port sampling data tell us?

If the number of vessels fishing is low, then the number of fish caught will also be low. Those fish that have been caught will be easily replaced by reproduction. If the number of fish caught is high, the number of adults left behind may not be high enough to increase the number of fish to their original level through reproduction. A healthy fish stock will have a good proportion of older mature fish that are capable of spawning and replenishing the stock. Port sampling allows us to keep an eye on the age structure of the stock. When we know the length of the fish, we can assign the correct age to that fish. The age of the fish is found by reading the number of lines on one of the fish's bones. This small bone, found near the brain, is called an otolith. The growth rings on the otolith are just like the growth rings

on trees. The rings are counted under a microscope and the average age can then be estimated for any length of fish.



Bigeye otoliths displayed on a finger



Cross section of a bigeye otolith showing daily growth increments

Here are some of the results from the study of tuna otoliths. Keep these tables in mind the next time you are sampling. Fishermen are always interested in this type of information.

Table 1: Length - age data for bigeye and yellowfin tuna

Fork length (cm)		Age (years)
Bigeye	Yellowfin	
65 cm	68 cm	1
95 cm	117 cm	2
120 cm	135 cm	3

Table 2: Fork length-age data for albacore (obtained from analysing vertebrae)

Fork length (cm)	Age (years)
47	1
50	2
57	3
65	4
73	5
79	6
85	7
88	8
95	9
96	10
97	11
105	12
107	13



How your port sampling data are used

Port sampling data are used to generate length-frequency graphs (the number of fish sampled versus the length in centimetres). Length-frequency graphs allow us to follow the different age groups as they grow, mature, and eventually die and leave the fishery. Fish tend to spawn at distinct periods. Fish spawned at the same time are roughly the same average length, although some fish will have grown larger and others will be smaller.

Length-frequency graphs

The following is an example of a typical length frequency graph that is produced from port sampling data. The number of fish measured is plotted against their length in centimetres. Fish that have spawned at the same time are known as a 'spawning class'. The two peaks on the graph represent the average length of the fish attained by each spawning class. In this example there are two spawning classes.

Length-frequency graph: An example

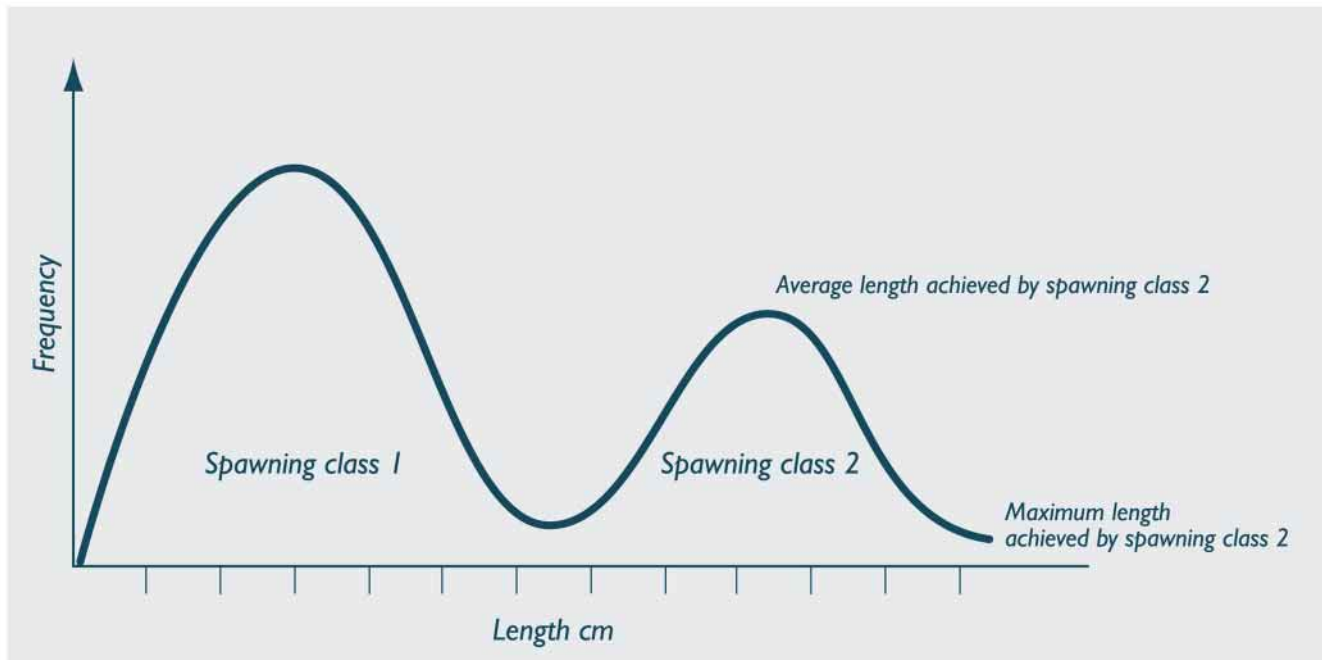

Length-frequency diagram

Length Frequency graphs from Port Sampling data

Here is an actual length frequency graph of big-eye generated from port sampling in Noumea, New Caledonia. It shows how the different spawning classes increase in length each month. (Notice how the average length moves a small bit to the right on each subsequent month, as the fish grow bigger.)

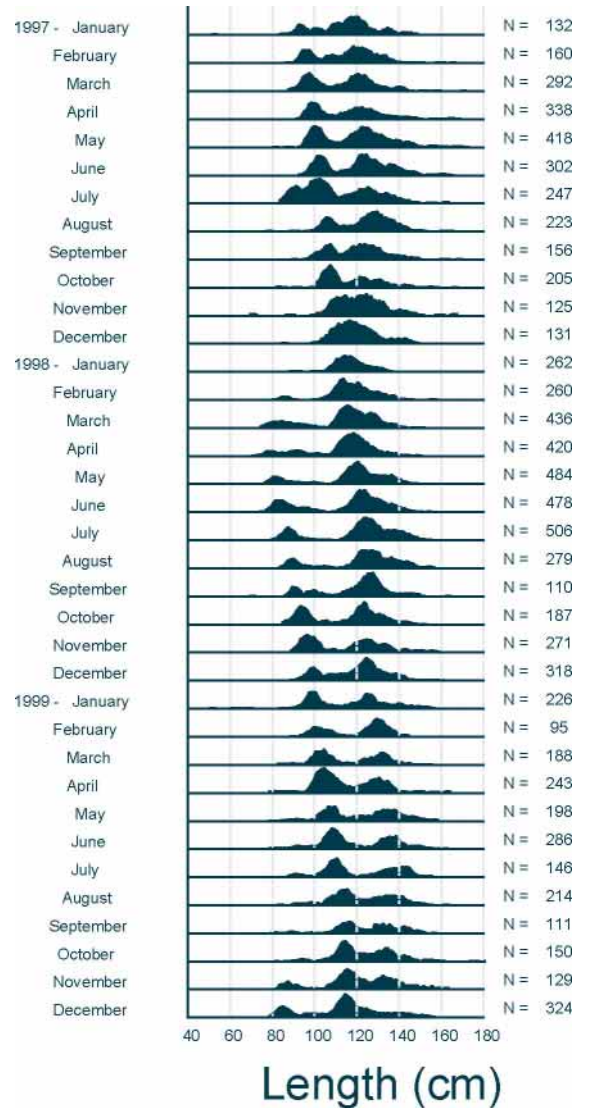

N= the number of fish measured during that month.



Chapter 3: The Basics

Be prepared !

Before you begin you will need to gather all of your equipment and tools together. *Don't go searching for your pencil and eraser the moment the boat comes in. Be prepared !*

The port sampler's checklist is short and simple:

- Pencils (we recommend # 2 or 2B pencils. They are darker so photocopies will be clearer.)
- Eraser
- Sharpener
- Clipboard
- Relevant set of forms
- Folder to store the completed forms
- Port sampler's shirt (Whenever possible wear your official port sampling shirt, especially on the first day of unloading.)
- Good working shoes
- Hard hat (At times hard hats are compulsory, please ensure you have one or have access to one.)

Be organised !

Supplies

SPC now supplies waterproof port sampling sheets for all fleet types. Store these blank data sheets together in one place. It will be easier to see when your supplies are running low. Be aware of how many sheets you typically use per month. Order new quantities from your fishery office or SPC in plenty of time. You should consider that air mail from SPC to many places in the region can take up to six weeks, while larger quantities

may, if sent by boat, take up to three months to reach some ports.

Put a filing system in place to compile your completed data sheets. All data sheets need to be copied. A copy should stay with the sampler (or fishery office) and the originals should be forwarded periodically to SPC. ***Port sampling data are valuable***; if they are lost, they can never be recovered. Take good care of them.

Calipers

To maintain your calipers in good working order, they must be calibrated regularly. Calibrating calipers ensures they work properly and that they record the correct length of the fish. To calibrate your calipers, measure a section of a measuring tape (or ruler) with your calipers. If you measure 25cm on the tape, your calipers should read 25 cm exactly.

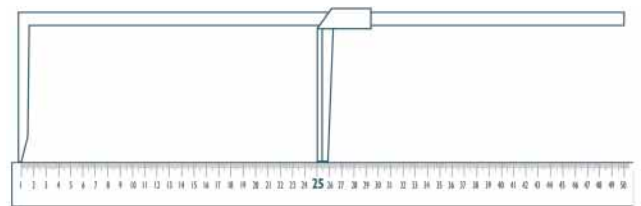

Calibrate your calipers regularly.

Sometimes calipers get knocked around or they may fall unintentionally and then the arms get bent. Bent calipers may give incorrect length measurements. If you calibrate your calipers and find they read greater than or less than a half a centimeter (0.5 cm) from the correct reading, you should attempt to fix them. If you cannot fix them, you should return them to the relevant authorities.

Postage

If you have been instructed to send your data directly to SPC, make a copy of the data, and then send the originals to:

Fisheries Database Supervisor
Oceanic Fisheries Programme
Secretariat of the Pacific Community,
B.P. D5
98848 Noumea Cedex
New Caledonia.

Sort your port sampling data and unloading sheets by month, before you send them to SPC.



“If you don’t treat the crew with respect...

Be Diplomatic !

As a port sampler your aim is to follow your sampling protocol while causing minimal interference to the unloading process. Having a good working relationship with the vessel and the captain is essential. Sometimes this is not an easy thing to achieve. Be considerate of the fact that at the end of their trip, both the captain and crew may be tired. They are eager to get the fish unloaded and enjoy their shore leave, which may be short. Filling in logsheets and hanging around waiting patiently for their fish to be measured may not be their idea of fun. Be patient, but be firm. In most cases fishing boats have a legal requirement to hand over their fishing logs and it is your job to collect such information.

The transient nature of some vessels also calls on the port samplers to improve their diplomacy skills. How you treat the crew, in your home port, may influence how they treat the port samplers in their next port of unloading. Port samplers should be aware that the captain and crew are often very



...they may treat other port samplers in the same manner ”



aware of the work that port samplers do. Hopefully they will come across port samplers in every harbour they visit. For this reason we ask samplers to broaden their view and realise that any bad behaviour on their part may make the job of the sampler in another port harder.

As someone representing your government, your own behaviour should reflect your position. Turning up on time is essential. And of course turning up sober is mandatory. If possible wear your official port sampling t-shirt, at least for the first day of the job. Most national programmes supply identification badges to their port samplers. Wear yours if you have one.

Don't wander into the accommodation areas of the boat without permission. Remember this is the crew's home. Do not remove any property that is not yours. Of course, the captain and crew should respect your duties and culture also. Report any difficulties or distressing behaviour you may encounter to your fishery officer. A few friendly words in the crew's own language will always lighten up the relationships you have with the crew. We have outlined some of the basic expressions on page X. Don't forget to teach the crew some of your own language, they will appreciate it.

Be smart !

Full instructions are given on the back of all port sampling sheets explaining what each data field means. Review these instructions regularly, especially if you are unsure of something. Always take time to review and read any new or revised data sheets that you are given.

Use the FAO code

All species should be recorded with their three-letter ASFIS (Aquatic Sciences and Fisheries Information Services) code. These species codes are assigned by the FAO (Food and Agriculture Organization) and used increasingly by fishery organisations around the world. SPC's species identification guide outlines the standard species codes for all the tuna and associated bycatch species caught in the Pacific. Some species are more difficult to identify than others. In this manual we have outlined the most challenging species identification when sampling purse-seine and longline vessels.

Group codes can also be used if the sampler cannot identify the exact species. An example of some group species are : BIL - billfish, BRZ - breams and pomfrets, SHK - Sharks. However, group codes should be avoided whenever possible. We expect they will only be used for heavily dressed or blast frozen fish and by inexperienced port samplers.

Fill in the Header Details

Make sure the header details (at the top of the form) are filled in on every sheet. Your sheets will be handled by a lot of people before they are finally filed away. Sheets may become separated during photocopying, filing and data entry. If you only complete the header details on the top sheet, we may not be able to identify the other sheets. If you are using a lot of sheets the second and subsequent sheets must state the port name, vessel name and date of sample.

Do not transcribe data

Use a pencil and your waterproof forms to record the data. Do not re-write your data after the port

sampling session. Don't worry if you have to hand in dirty or stained sheets, it shows you are working hard!

Check for errors

Many of the errors made by port samplers could be avoided if they spent a small moment checking their sampling sheets at the end of every session. The most common, but often the most critical error made by samplers, is leaving data fields blank. In their haste, samplers may not fill in the header information or even the length codes while they are sampling. They intend to fill these in later but then they forget.

Spend time checking your sampling sheets at the end of every sampling session.

Recording vessel details

Before you start your port sampling work you need to record the details that will identify the fishing vessel and the fishing area. It is important you do this. Some information is vital and your sampling data cannot be used without it. The vessel's name and the date of the sample are two such critical fields.

Vessel name: *This is a critical field.* Record the full name of the vessel. Do not record an abbreviated name. Even if everyone in your harbour knows 'F.V. Kou You Maru # 3', as 'Number 3', use the full name every time. Be aware that your data are used by a lot of people who will not know the local name for the vessels.

Date of sample: *This is a critical field.* The date of the sample allows us to match your sampling data with the vessel's logsheet. In some cases the vessel may not hand its logsheet to you, but will hand it on to SPC, through its fishing agent and country representative at a later date. If we have the date of your sample we will be able to match your data to the logsheet data. The date of the sample may also indicate the probable date of capture.

Fishing area. *This is an important field.* The port sampling data you collect are only useful if we know the area that the fish were caught in. This is because fish from different areas grow at different rates. You should have access to the vessel's logsheet. In most countries it is mandatory for vessels to give port samplers access to their logsheets. For some vessels (those fishing on the high seas for instance), it may not be mandatory to hand in logsheets, but legislation in this area is increasing and we



expect with time that more vessels will be required to supply logsheets.

It is easier for everyone if the port sampler records the fishing area information from the logsheet. Typically, all logsheets are forwarded to SPC eventually, although in some cases this can be up to a year later.

Vessel logsheets

When you collect a logsheet, make sure that the vessel's name is filled in on the logsheet and it is legible.

When you collect a logsheet, make sure that the vessel name is recorded on all logsheets you collect. If the vessel name is missing – this is not common, but it does happen – the information the logsheet contains will be useless. Another difficulty is when a vessel's name is recorded in Chinese characters only. As the port sampler you are in the best position to record the name of the vessel in legible characters. This problem is most common when the vessel uses non-standard logsheets or copies of its own logbook.

Recording the fishing area*

(*The actual set positions must be recorded for purse-seine vessels; this is dealt with on page 64)

Fishing areas are recorded in latitude and longitude.

- **Latitude** is the location north or south of the equator.
- **Longitude** is the location east or west of the prime meridian (Greenwich, London.)

From the logsheets

The fishing area is easily obtained from the vessel's logsheet. Scan through the fishing positions on the completed logsheet. To get the range of the latitude, scan down the latitude positions and record the most northerly position and then the most southerly position. To get the range of the longitude, scan down the longitude positions and record the most westerly position and then the most easterly position. It will help if you have a good understanding of the Pacific Ocean's coordinates. A map is displayed on page 32.

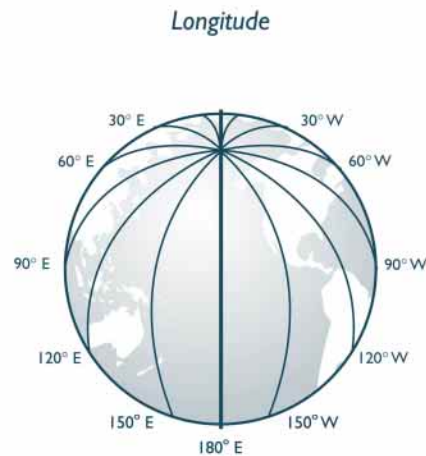
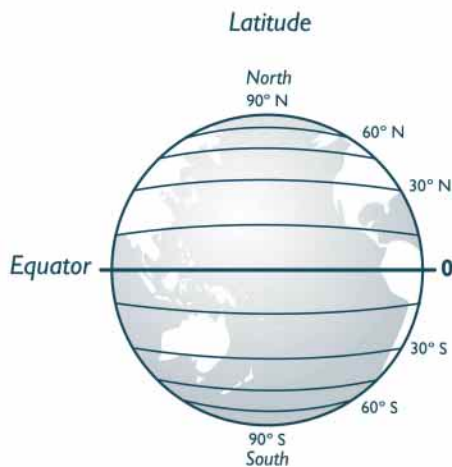

For example:

Choose the fishing area from the following fishing positions. The answer is written out below.

02° 23 576 N	170° 36 856 E
01° 45 624 S	179° 51 234 E
15° 28 357 S	176° 12 287 W
17° 56 764 S	145° 45 654 E
07° 12 345 S	142° 34 234 E
06° 46 234 S	135° 45 637 E

A word of warning. Don't just look for the highest and lowest digits when you scan through the fishing positions. You need to take the N, S, E, and W coordinates into consideration. Remember that 01°N is to the north of 02°S. You should also be careful with longitude positions which cross the International Dateline (180°). Note that 176°W is further west than 179°E.

FISHING AREA	FROM LATITUDE	02°23.576	(N)	TO LATITUDE	17°56.764	(N)	FROM LONGITUDE	135°45.637	(E)	TO LONGITUDE	176°12.287	(E)
			(S)			(S)			(W)			(W)

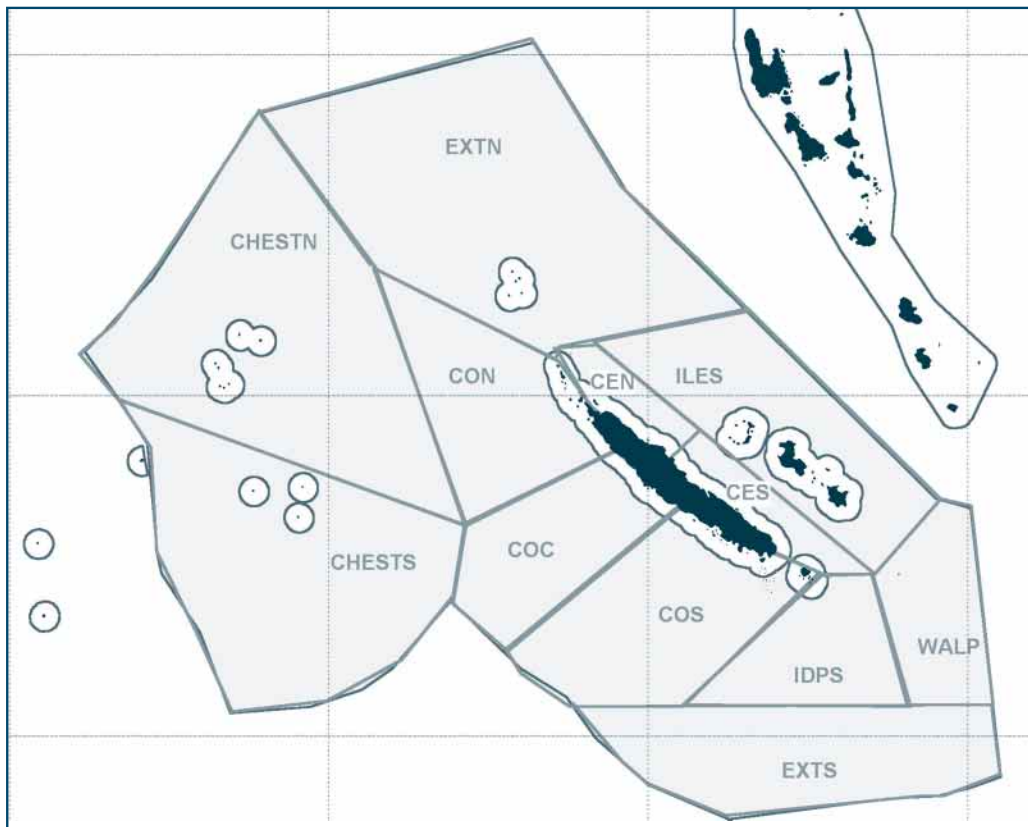

New Caledonian Fishing Map



From local fishing maps

Some fishing boat captains will be more comfortable telling you the broad area in which they have fished. Some have their own fishing maps that mark out specific areas. You can record these broad fishing areas instead of the logsheet positions as long as a map of the area has been provided to SPC. The fishing map on page 12 is used by the local fleets in New Caledonia. The sampler shows the map to the captain and asks which area they were fishing in.

From a 5° x 5° map

If there are no local fishing maps in use in your area and the captain is reluctant to provide logsheets, you could ask them to indicate which 5° x 5° area they were fishing in. A full explanation of 5° x 5° fishing areas is provided on page 32. SPC can provide you with a 5° x 5° map for your local fishing area. It is then a simple task of asking the captain to select which 5° x 5° square of the ocean he was fishing in. Broader scale maps (10° x 10° or 10° x 20°) can also be used.

Sampler and assistant: The names of the sampler and the assistant allow us to identify who did the port sampling work. This helps to identify which samplers are fully competent and which samplers need further guidance with their work. It may also be important if you are getting paid by the number of samples you do. Write your name clearly, so it can be entered on the data base easily.

Country of registration: The vessel's country of registration should be easily picked up from the marking on the transom (back) of the boat. The nationalities of the captain and crew may have no

bearing on the country of registration of the vessel. A vessel with mostly Taiwanese crew may be registered in Belize for instance. If you are unsure, check the vessel's license – this is often displayed in the wheelhouse – or ask your fishery officer.

Registration number: This is the registration number in the country of registration. This may be written on the side of the boat, but more likely you will have to search for it, by checking the licence in the wheel house or by asking a fishery officer.

Trip dates: By filling in the date of 'the start of the trip' and the 'end of the trip' you will allow us to match up your port sampling data with the correct logsheet quickly and efficiently.

Page ___ of ___: Port sampling sheets should be numbered according to each vessel you have sampled. Each vessel you sample is one sampling session. Number your sheets consecutively until you have finished sampling the vessel. Complete the field by filling in the total amount of pages that you have used e.g. 'page 1 of 3', 'page 2 of 3', 'page 3 of 3'. Filling in the page numbers on your sheet is important and helps the many people who will deal with your data after they have left your hands.

Recording the length measurements

As a port sampler your main job is to record the length measurement of the fish.

Length measurements are **rounded down** to the nearest whole centimetre.

- If the length of the fish is **71.1 cm** you record **71 cm** on your data sheet.
- If the length of the fish is **71.5 cm** you record **71 cm** on your data sheet.
- If the length of the fish is **71.8 cm** you record **71 cm** on your data sheet.

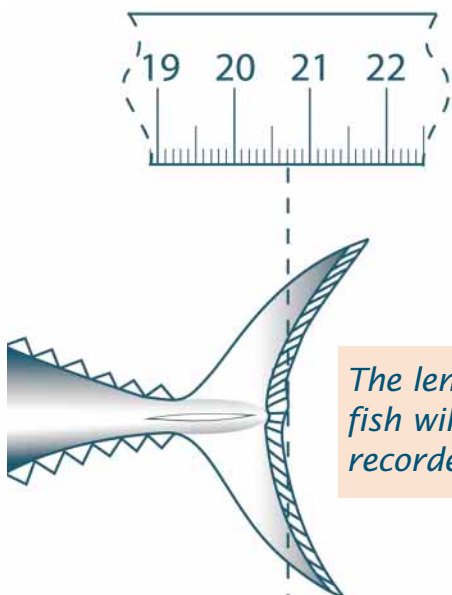

The length of this fish will be recorded as **20 cm**.

Length measurements are rounded down.

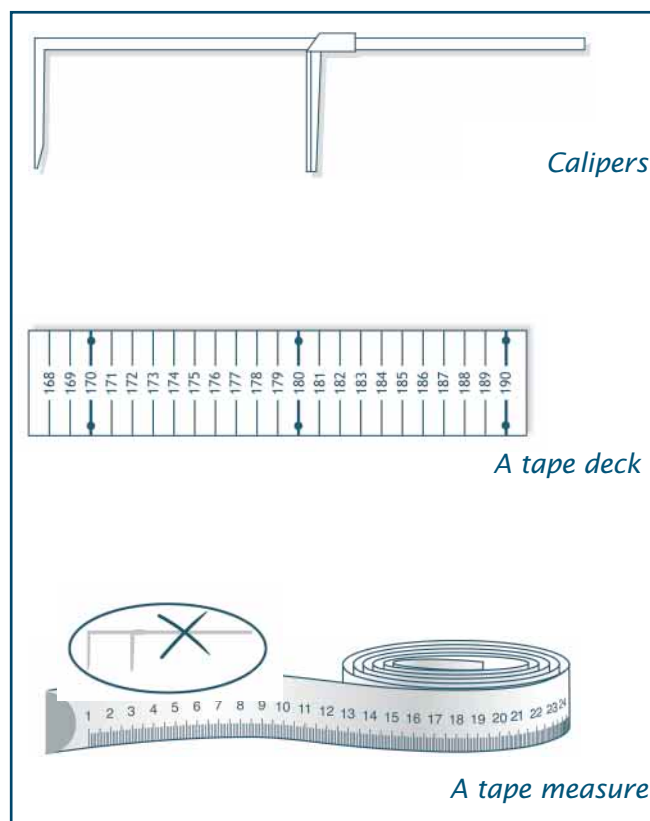

Calipers and sometimes tape decks can be used to record length measurements. Tape measures must **never** be used.

You should aim to *always measure fish with calipers*. Calipers give the most accurate and reliable results. Longline port sampling should *always* be done with calipers. On purse-seine vessels the large amounts of smaller skipjack may be more comfortably measured with a tape deck. *If you do decide to use a tape deck you must place it under the fish with the start of the ruler against a raised hard object*. This way you will ensure that the nose of the fish is aligned with the zero mark on the tape deck. If you don't, it will be easy for the fish to slip down the tape measure while you are measuring it, giving you an incorrect record.

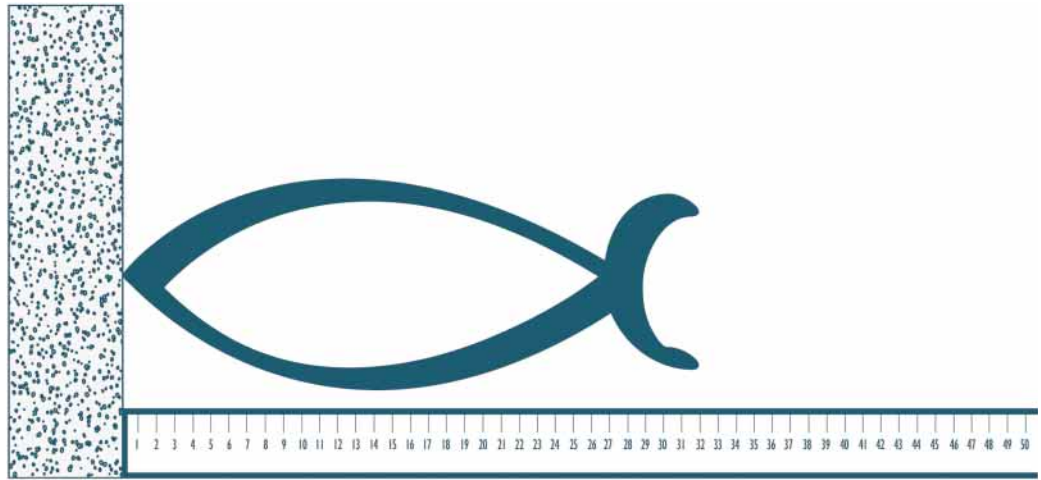

The tape deck must be placed under the fish and against a raised hard object.

Be careful of a problem called parallax when you use a tape deck. To read the correct measurement using a tape deck you must have your eye directly above the tail of the fish. If you move your head to either side, you will read the ruler at an angle and you will not read the correct measurement.

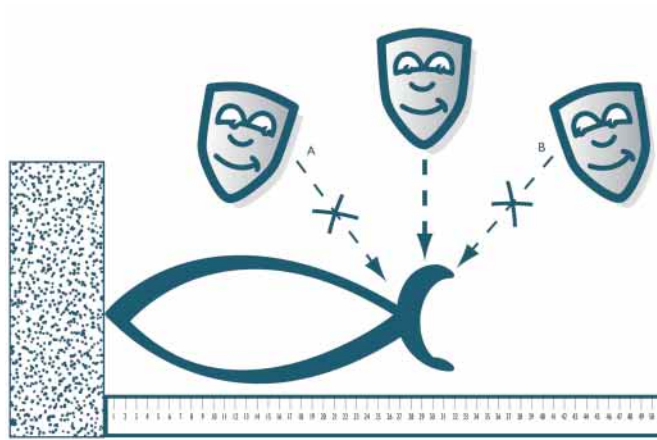

Your eye must be directly above the tail of the fish to get the correct length.

Never use a tape measure to measure fish.

Using a tape measure is fraught with problems, and it is likely that you will record an incorrect length if you use one. When using a tape measure port samplers are inclined to place it above the fish. This way the tape measure becomes curved, adding extra centimetres to the true length. Also, tape measures, which are made from fabric, are prone to stretching in the wet environment.

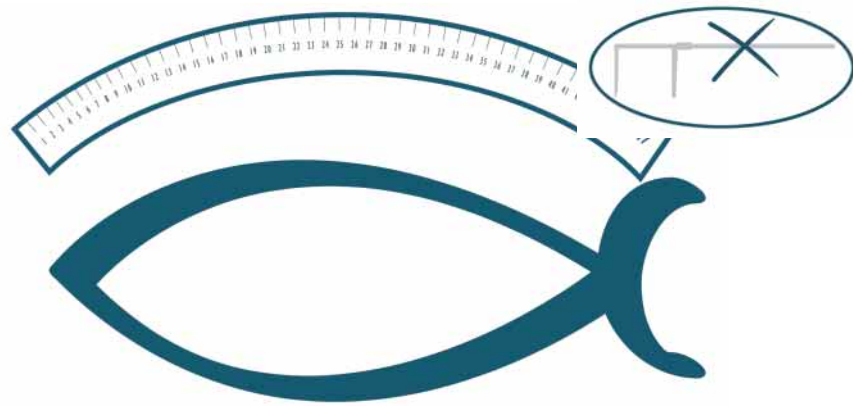



Regional standard length Measurements

Fundamental to the port sampler's job is measuring the length of fish. SPC has limited the number of standard length measurements it asks port samplers to collect. When you record the length of the fish, you must also record the length code for it. This will indicate which type of length measurement you made.

You should aim to always measure the entire length of the fish using the following length codes.

- For whole fish and sharks take a UF code measurement [upper jaw (upper snout for sharks) to the fork in the tail]
- For whole billfish record a LF code measurement [from the lower jaw to the fork in the tail].

When fish have been processed or 'dressed' (i.e. the head or tail has been cut off) it may not be possible to record the entire length of the fish. In that case, SPC has a number of standard

length measurement codes that can be used. Please note, however, that you should only use these length codes if a part of the fish has been cut off. SPC will, by using conversion factors, eventually convert these 'dressed fish' length codes back to the UF or LF length code. If you collected a dressed length code for a fish that has not been processed you are only creating extra work for SPC!

'Dressed fish' length codes are only to be used when some part of the fish has been removed.

- For all fish (except billfish) where the tail has been cut off, use a US measurement code [upper jaw to second dorsal fin].
- For billfish where the tail has been cut off, use a PS code (outlined below).
- For all fish where the head has been cut off use a PF measurement code [pectoral fin to the fork in the tail].
- For all fish where the head and tail have been cut off use a PS measurement code [pectoral fin to second dorsal fin].

Whole Fish

UF

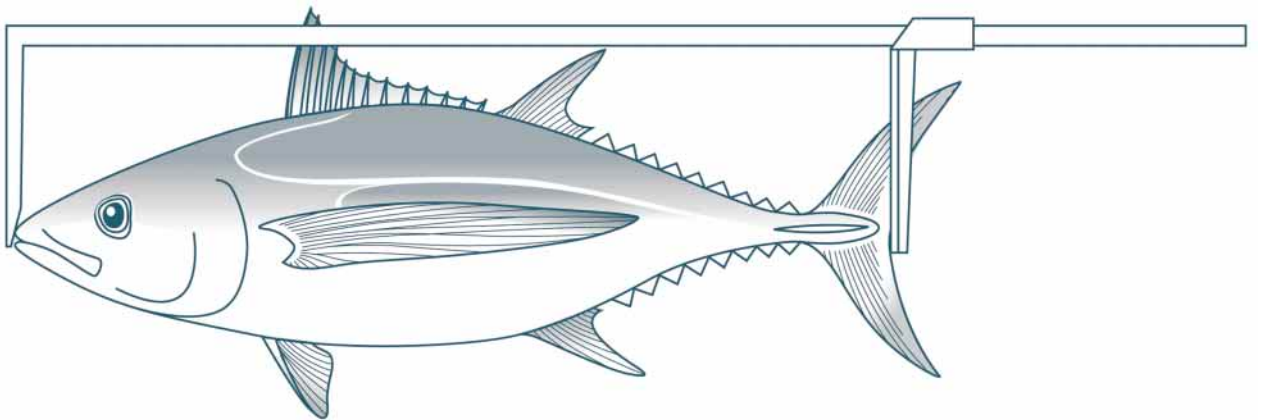

UF: Upper jaw to the fork in the tail



Whole Fish: Sharks

UF

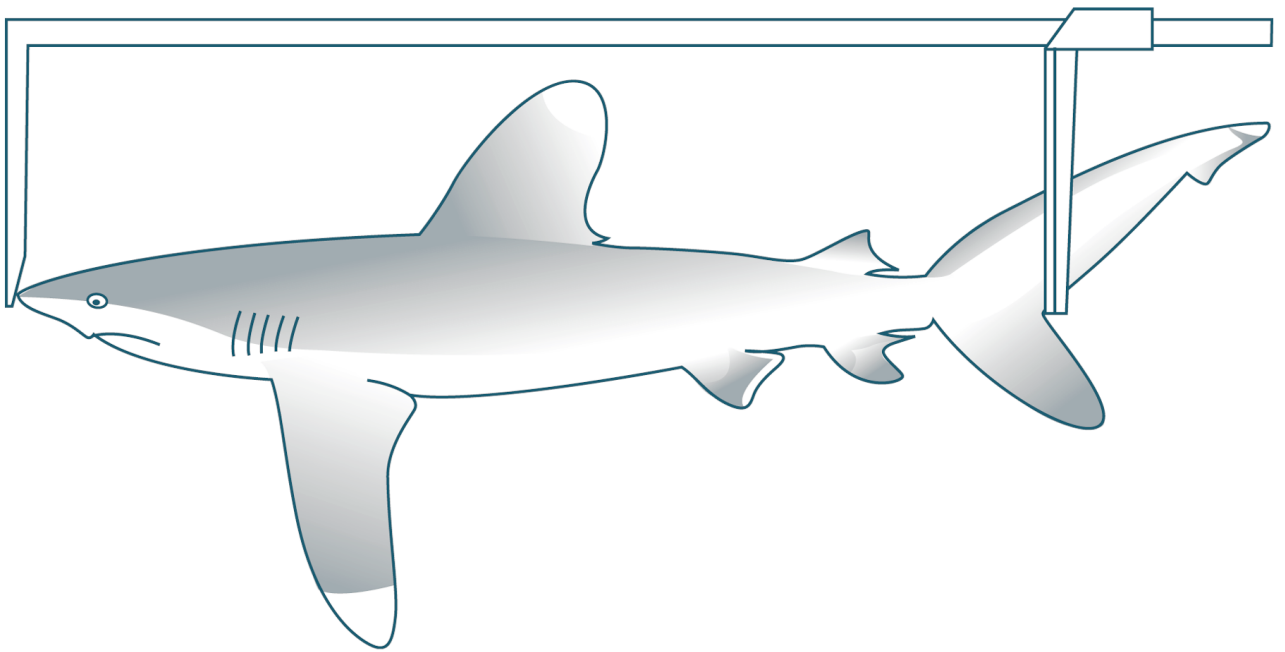

UF: Upper snout to fork in tail

Whole Fish: Billfish only

LF

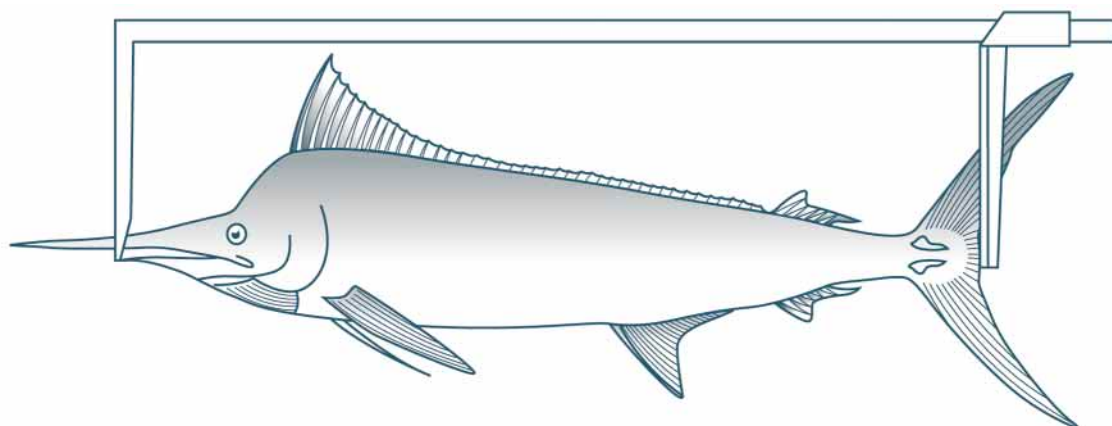

LF: Lower jaw to fork in tail



Dressed fish

For all fish (except billfish) where the tail has been cut off.

US

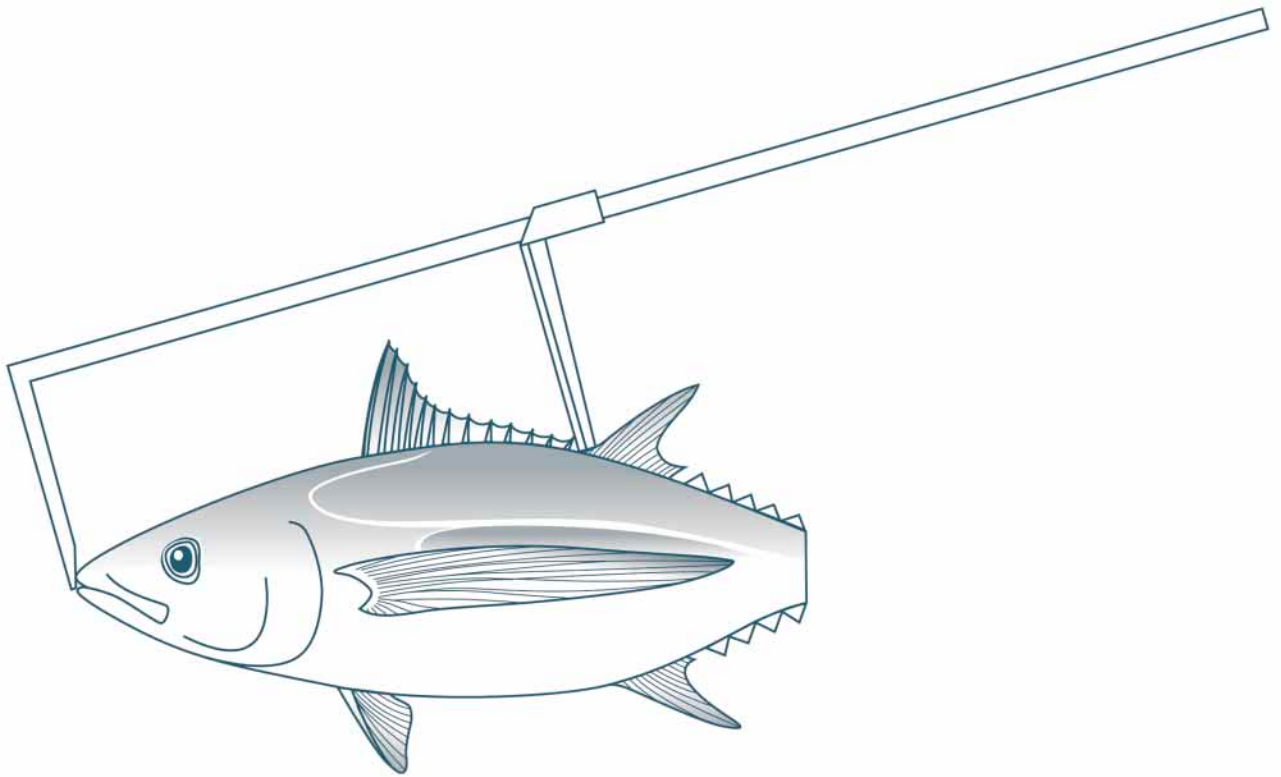

US: Upper jaw to second dorsal fin

(*Note: Do not use this measurement for billfish. For billfish where the tail, but not the head, has been cut off, use the PS code.)

Dressed fish

For all fish where the head has been cut off

PF

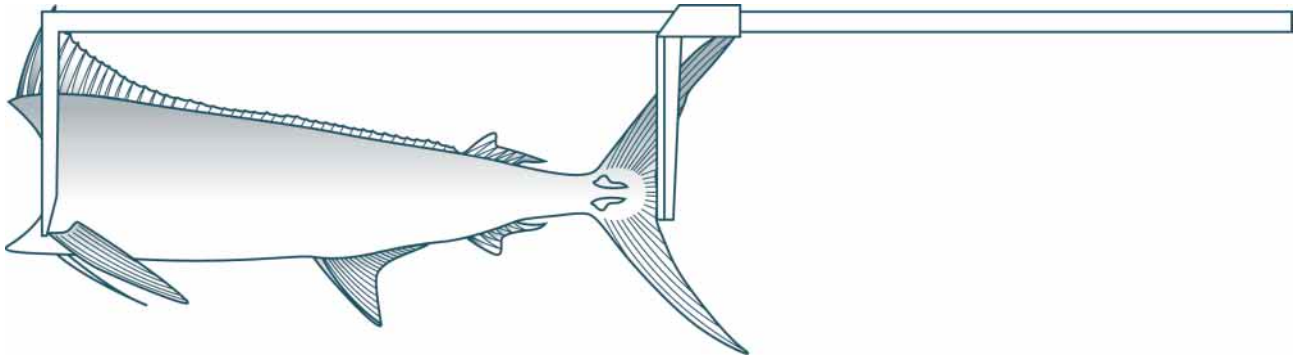

PF: Pectoral fin to fork in tail



Dressed fish

For all fish where the head and tail have been cut off

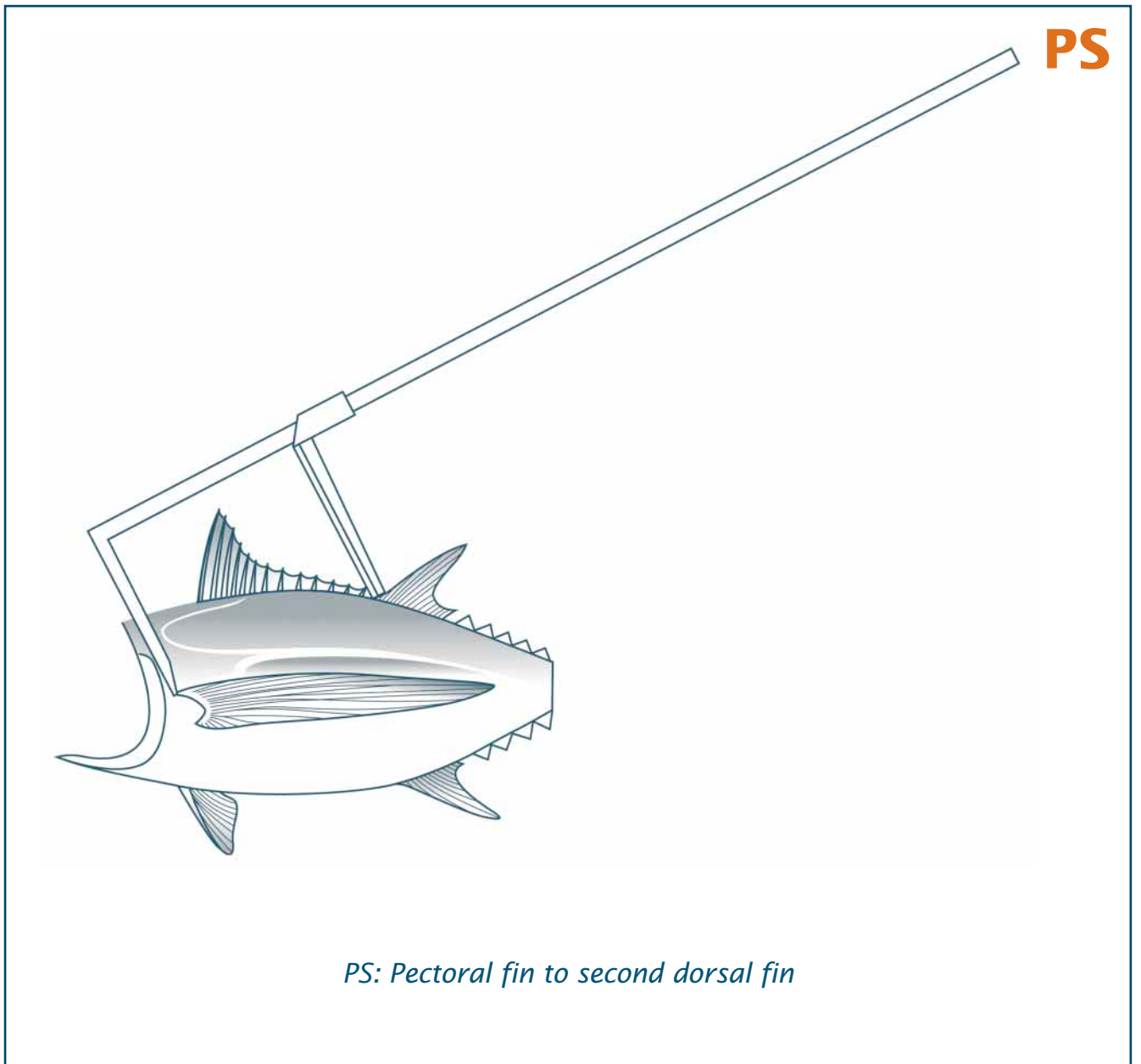

PS: Pectoral fin to second dorsal fin

Some other things to note when taking standard length measurements

- The measurement is always to the **front** of the pectoral fin and to the **front** of the second dorsal fin.
- Make sure that you can actually see the fin! Some samplers are tempted to measure to the area where they think the fin should be but they can't actually see it, because the area where the fin is attached has been cut off. So make sure you can see the fin or at least the scar from where it was originally attached to the body.

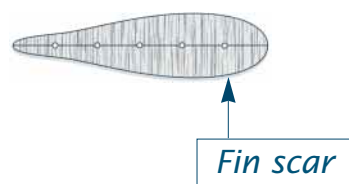

Don't measure fish that have been cut off behind the pectoral fin. Make sure you can actually see the pectoral fin or the pectoral fin scar if you do a pectoral fork measurement.

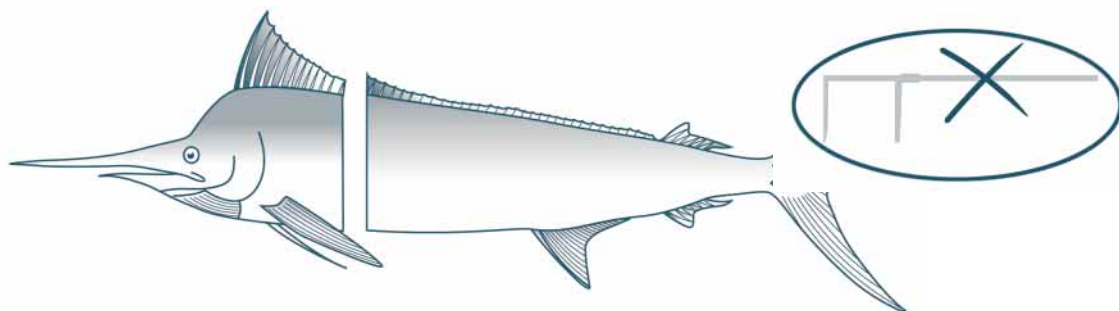

- **Never** measure curved or damaged fish. You will frequently come across fish with broken or detached tails on purse-seine vessels. Just set them aside and measure another fish.

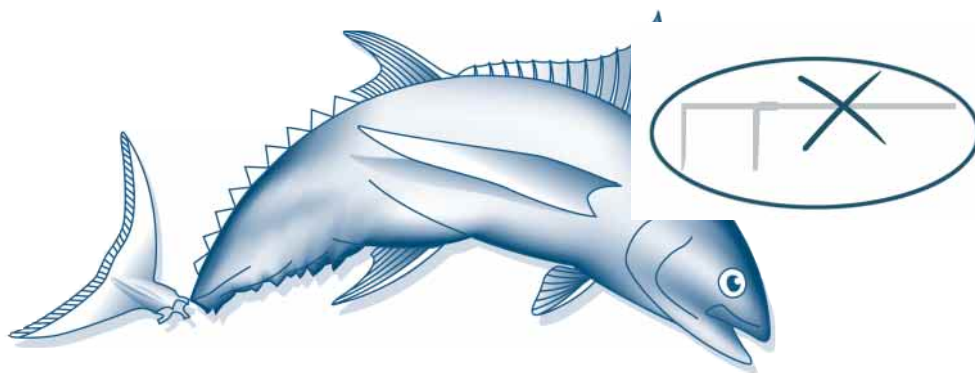



- Don't measure fish on top of other fish. Place them on a flat surface. Fish measured on top of other fish will be curved.
- Is the fish longer than your calipers? Don't despair. Just use your calipers a second time. Place a small mark in the middle of the fish where your calipers end, and then do a second measurement from that point. Add the two lengths together and record this number as your length measurement. Don't forget to record the length code. For instance the length code for the measurement below is LF.

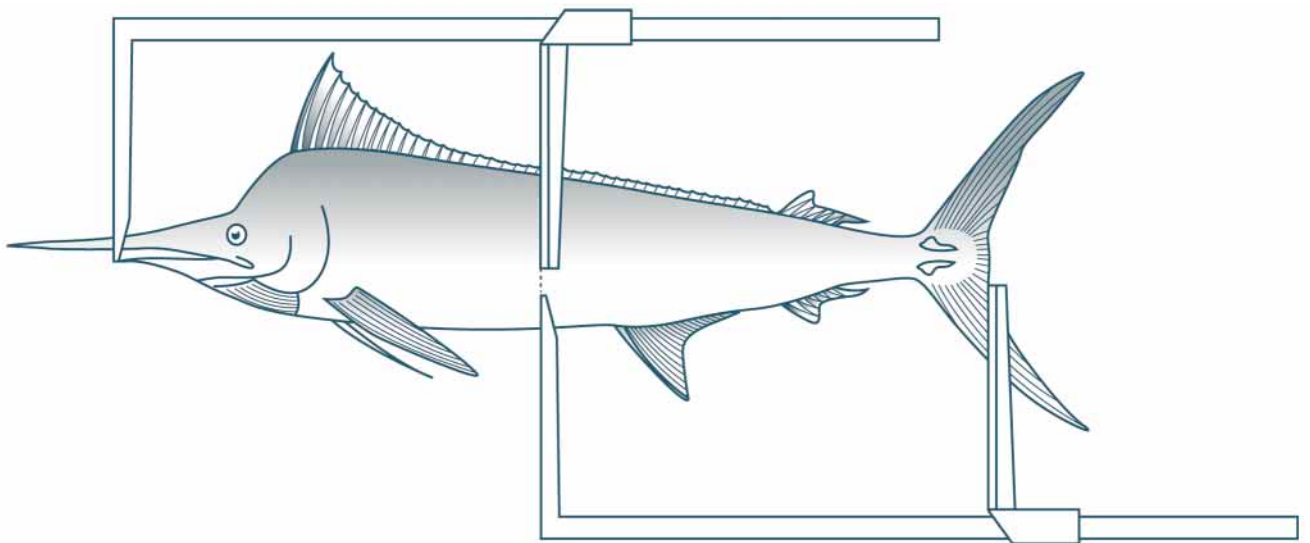

Recording the weight measurements

Weight measurements are **rounded up** to the nearest kilogramme.

- If the weight of the fish is **45.3 kg** you record **46 kg** on your data sheet
- If the weight of the fish is **45.5 kg** you record **46 kg** on your data sheet
- If the weight of the fish is **45.8 kg** you record **46 kg** on your data sheet.

This is a bit surprising as it is opposite to the length measurement, which you round down. The logic behind this is simple.

For the weight of the fish, there can be some weight loss between the time of capture and time it is weighed, through dehydration or loss of mucus. To compensate for this loss we round the weight of the fish up to the nearest kilogram.

Weight codes

If it is possible for you to record the weight of an individual fish that you have measured, you should do so. Do not record the weights of

multiple fish. If fish are weighed in multiples (if for instance 3 or 4 fish are put on the scales at the same time), do not record these weights.

When you do record the weight of a fish, you will need to record a weight code as well, to describe if the fish was whole or partially processed. A fish weight without a weight code cannot be used and you will have worked in vain.

*The port sampler's primary aim is to measure the length of the fish. Samplers are strongly advised **not to collect weight-only data** for fish without prior consultation with SPC.*

SPC uses standard weight codes. These are:

- **WW** – whole weights: is used for whole fish, which have not been processed in any way.
- **NM** – not measured: when you normally record fish weights, but were unable to get the weight for some of the fish.
- **SF** – shark fin.

For all species, except billfish, we use:

Code

GG – Gilled and gutted

GT – Gilled, gutted, and tailed

GX – Gutted, headed, and tailed

For billfish, we use:

Code

GH – Gilled and headed

GO – Gutted only, not gilled

GX – Gutted, headed, and tailed



Chapter 4: Port Sampling for Purse-seine Vessels

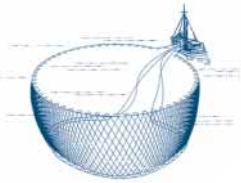

Aim: To identify wells which contain fish that were caught with the same school association, caught in the same month, and caught in the same area, and then to randomly sample five fish from every net that is unloaded from the well.

Purse-seine port sampling is different to long-line sampling. The working day, your duties and the type of species you encounter are all different. Although some purse-seiners have home ports, many are transient, moving from one port to another depending on which licensing agreements they have and where the fish are to be found. This in itself can present a problem for the port sampler. It is difficult, especially for an inexperienced observer, to keep skills fresh and sharp when there are no unloadings. If you have been idle for a while we suggest you renew and review your skills with this manual.

Port samplers should accompany the fishery officer when they first board the vessel. The fishery officer should then give a copy of the logsheet to the port samplers. With a copy of the logsheet in hand the port samplers can make the decision as to which wells are appropriate for sampling and which are not. Port sampling cannot proceed onboard a purse-seiner if the vessel has not filled in the well numbers on its logsheet. *If the well numbers have not been filled in, the logsheet should*

be returned to the captain of the vessel with a request that he fills in the well numbers.

One cultural mis-understanding you may come across on purse-seiners is the seating arrangements. In the wheelhouse and in the galley, certain chairs may be reserved for the captain's use only. The crew are likely to get upset if you sit in the captain's chair, so it is always better to ask first.



On purse seiners especially, some seats are reserved for the captain's use only. Check before you sit down !

How to choose an appropriate well for purse seine sampling

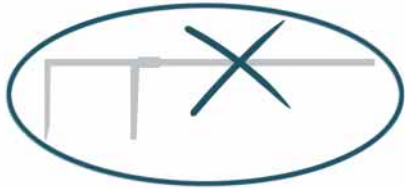

Never ever measure fish from the dry lockers.

Dry lockers are storage areas often placed in the side walls of the wet deck. They are typically found on Taiwanese boats. The fish in dry lockers have probably been transferred and mixed in with fish from a variety of other wells. It is often difficult to trace the origins of these fish. Do not sample fish from the dry lockers. If someone, not understanding your sampling protocol, directs you to sample the dry lockers, explain the situation to them calmly. Eventually they will get used to the fact that port samplers never sample the dry lockers.

At the start of the day, find out which wells will be unloaded first. Sometimes two or more wells will be unloaded at the same time. On the following pages we show you how to check the logsheets to select the most appropriate wells for sampling. A step-by-step guide to selecting wells for purse-seine port sampling is presented on page 64.

If two or more wells are appropriate for sampling and match the criteria below, you are lucky you can make your own decision as to which one to sample. If no well is appropriate for sampling, take a rest. Do not let anyone persuade you to sample an inappropriate well.

Criteria for sampling wells

Only sample wells with fish that:

- have the same school association
- were caught in the same calendar month
- were caught in the same area

1. With the same school association

You must ensure that all the fish in the well you sample have the same school association.

Tuna regularly swim towards and around floating objects. The type of object can vary widely, from a floating coconut to a large tree trunk. Increasingly, fishermen take advantage of this knowledge and construct floating objects of their own to catch fish. Some use manmade rafts and mark them with a radio buoy, so they can return to them repeatedly. Or they may choose to anchor these rafts permanently to the sea floor.

The absence or presence of a floating object with a tuna school, as well as the particular type of the floating object, is known as the 'school association'. Tuna caught from different school associations will vary in average length and in species composition. Scientists need to know the type of school association the fish came from to analyse the sampling results properly.



The same school association codes are used on the logsheets and observer forms, so you should recognise them. The school association codes are:

- | | |
|---|---------------------------------|
| 1. Unassociated | 5. Anchored raft, FAD, or Payao |
| 2. Feeding on baitfish | 6. Live whale |
| 3. Drifting log, debris, or dead animal | 7. Live whale shark |
| 4. Drifting raft, FAD (Fish Aggregating Device), or payao | 8. Other |

How to check the logsheet to determine the school association of the fish in a well:

- Look at the vessel's logsheet.
- Check down the 'well numbers' column on the logsheet.
- When you spot the well number for the well you want to sample, highlight it. Then highlight the entire line on the logsheet where that well number is written.
- Remember, a well number may be written more than once; highlight the entire line every time it appears.
- Check that the school association codes on these highlighted lines are all the same.

Logsheet example:

MONTH	DAY	ACTIVITY CODE	01:00 UTC OR SET POSITION				SCHOOL ASSOC CODE	SET START TIME	RETAINED CATCH					
			LATITUDE DDMM.MMM	N S	LONGITUDE DDDMM.MMM	E W			SKIPJACK WEIGHT	YELLOWFIN WEIGHT	BIGEYE WEIGHT	OTHER SPECIES		WELL NUMBERS
												NAME	WEIGHT	
4	1	3	00.05.127	S	153.45.986	E								
4	2	2	02.01.543	S	154.19.285	E								
4	3	1	02.32.576	S	152.37.732	E	4	50	30	5				P2, P3
4	3	1	02.17.358	S	151.27.678	E	1	40						S2
4	3	1	02.01.943	S	152.54.876	E	4	30	10	1				P3, S3
4	4	2	04.53.847	S	152.51.742	E								
4	5	1	04.01.942	S	154.43.354	E	4	20	10	1				P4
4	5	1	04.01.487	S	154.37.753	E	1	50						P4, P5

school association ↑

For instance, the school association of the fish in the well on this example logsheet are:

Well no. P2

was filled with school association '4' on the 3rd April (1st set of the day).

Well no. P3

was filled with school association '4' on the 3rd April (1st set of the day).

was filled with school association '4' on the 3rd April (3rd set for the day).

Well no. S3

was filled with school association '4' on the 3rd April (3rd set for the day).

Well no. S2

was filled with school association '1' on the 3rd April (2nd set for the day).

Well no. P4

was filled with school association '4' on the 5th April (1st set of the day).

was filled with school association '1' on the 5th April (2nd set of the day).

Well no. P5

was filled with school association '1' on the 5th April (2nd set of the day).

1 = Unassociated

4 = Drifting raft, FAD, or payao

Which of these wells are appropriate for sampling?

- Wells no. P2, P3 and S3 are filled with fish who have school association 4 only.
- Wells no. S2 and P5 are filled with fish who have school association 1 only.

These wells are appropriate for sampling

- Well no. P4 is filled with fish who have school association 1 and 4.

This is a mixed well. This well is not appropriate for sampling.



2. The same calendar month

You must ensure that all the fish in the well you sample were caught in the same calendar month.

Since tuna grow with time, scientists need to know the approximate date of capture for the tuna. When they do their analysis, they separate fish which were caught during different months. You will need to do this also.

How to check the logsheet to determine the calendar month of the fish in a well:

Logsheet example:

- Look at the vessel's logsheet.
- Check down the 'well numbers' column on the logsheet.
- When you spot the well number for the well you want to sample, highlight it. Then highlight the entire line on the logsheet where that well number is written.
- Remember, a well number maybe written more than once highlight the entire line every time it appears.
- Check that the months on these highlighted lines are all the same.

MONTH	DAY	ACTIVITY CODE	01:00 UTC OR SET POSITION				SCHOOL ASSOC CODE	SET START TIME	RETAINED CATCH					
			LATITUDE DDMM.MMM	N S	LONGITUDE DDDMM.MMM	E W			SKIPJACK WEIGHT	YELLOWFIN WEIGHT	BIGEYE WEIGHT	OTHER SPECIES		WELL NUMBERS
												NAME	WEIGHT	
4	1	3	00.05.127	S	153.45.986	E								
4	2	2	02.01.543	S	154.19.285	E								
4	3	1	02.32.576	S	152.37.732	E	4	50	30	5				P2, P3
4	3	1	02.17.358	S	151.27.678	E	1	40						S2
4	3	1	02.01.943	S	152.54.876	E	4	30	10	1				P3, S3
4	4	2	04.53.847	S	152.51.742	E								
4	5	1	04.01.942	S	154.43.354	E	4	20	10	1				P4
4	5	1	04.01.487	S	154.37.753	E	1	50						P4, P5



calendar month

In this example, all the fish were caught in the same calendar month '4' – April.

3. The same area

You must ensure that the fish in the well you sample come from the same 5° x 5° area.

Not all areas of the Pacific Ocean are equal in the eyes of scientists. Some areas are more productive than others, because of factors such as plankton levels and the absence or presence of sea mounts, which affect fish production. Fishing vessels may also show a preference for certain fishing areas. Scientists need to keep these things in mind when assessing stocks, so must a sampler.

So what is a five-by-five degree area?

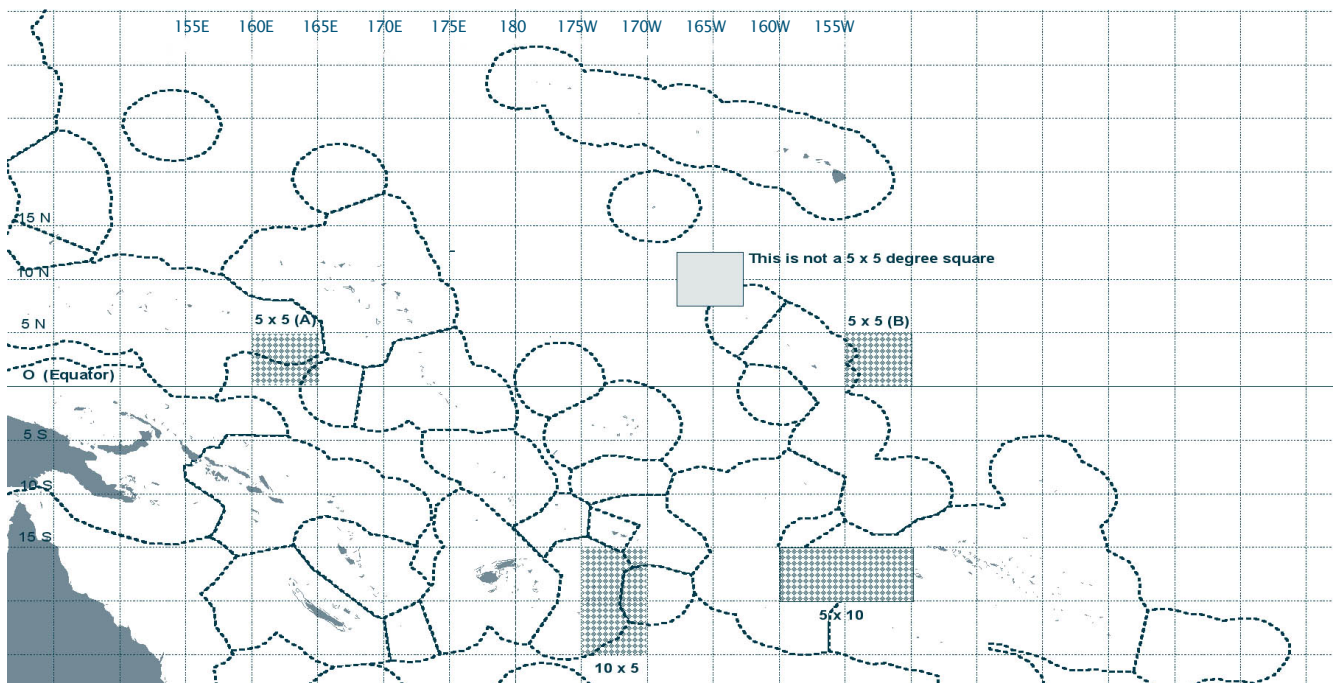

A 5° x 5° area has 5 degrees of latitude in width and 5 degrees of longitude in height. The area must start and finish on a line of longitude and latitude that is a multiple of 5.*

The squares marked A and B on the map above are 5° x 5° areas. The other square is not a 5° x 5° square as it does not start on lines of longitude and latitude which are multiples of 5. You may be asked to extend the limits of your fishing area to a 5° x 10° / 10° x 5° area (both shown above), or even to a larger 10° x 10° area, or perhaps a 20° x 20° area.

*[The numbers 5, 10, 15.... 150, 155, 160, 165 are all multiples of 5. Zero (0) is also considered a multiple of five for this exercise].



How to check the logsheet to determine the 5° x 5° square of the fishing position for the fish in a well.

- Look at the vessel's logsheet.
- Check the 'well numbers' column on the logsheet.
- When you spot the well number for the well you want to sample, highlight it. Then highlight the entire line on the logsheet where that well number is written.
- Remember, a well number maybe written more than once, highlight the entire line every time it appears.
- Check that the fishing positions on these highlighted lines are all in the same 5° x 5° area.

Logsheets example:

MONTH	DAY	ACTIVITY CODE	01:00 UTC OR SET POSITION				SCHOOL ASSOC CODE	SET START TIME	RETAINED CATCH				
			LATITUDE DDMM.MMM	N S	LONGITUDE DDDMM.MMM	E W			SKIPJACK WEIGHT	YELLOWFIN WEIGHT	BIGEYE WEIGHT	OTHER SPECIES	
											NAME	WEIGHT	
4	1	3	00.05.127	S	153.45.986	E							
4	2	2	02.01.543	S	154.19.285	E							
4	3	1	02.32.576	S	152.37.732	E	4	50	30	5			P2, P3
4	3	1	02.17.358	S	151.27.678	E	1	40					S2
4	3	1	02.01.943	S	152.54.876	E	4	30	10	1			P3, S3
4	4	2	04.53.847	S	152.51.742	E							
4	5	1	04.01.942	S	154.43.354	E	4	20	10	1			P4
4	5	1	04.01.487	S	154.37.753	E	1	50					P4, P5

↑ fishing area

Q: How do I find which 5°x5° area the fishing positions are in?

A: You can find the area that the fishing position(s) are in by getting the four coordinates of the 5° x 5° area. To find the coordinates of the 5° x 5° area, you only need to look at the degree segment of the fishing position.

DD **MM.** **MMM** **N/S** **DD** **MM.** **MMM** **E/W**
05° **13.** **654** **N** **165°** **46.** **735** **E**

DD denotes degrees
MM denotes minutes
MMM denotes decimal minutes

- You can find the coordinates of the 5° x 5° area by finding the first number that ends in a zero or a five, which is immediately before and after the degree number. (Hint: Use a number line.)
- Check all the fishing positions of the fish in the well (i.e. check all the highlighted fishing positions).
- The highlighted fishing positions should all fall within the same 5° x 5° area.

To find a 5° x 5° area:

Example: fishing position: **04° 01. 487 S 154° 37.753 E**

Latitude:

04°: 0 1 2 3 **4** 5 6 has the coordinates **0°–5° S.**

Longitude:

154°: 150 151 152 153 **154** 155 has the coordinates **150°–155° E.**

**Therefore the coordinates of your 5° x 5° square are:
latitude 0°–5° S, and longitude 150°–155° E.**

*Special case: If the degree number is a multiple of 5, then select that number and the next higher multiple of 5.

Example fishing position: **05° 13. 654 N 165° 46. 735 E**

Latitude: 05° 13. 654 N = **05° N** has the coordinates **05°–10° N.**

Longitude: 165° 46. 735 E = **165° E** has the coordinates **165°–170° E.**

**Therefore the coordinates of your 5° x 5° square are:
latitude 5°–10° N, and longitude 165°–170° E.**

If you cannot find a well where all the fish come from the same 5° x 5° square, but they do have the same school association and calendar month, you can extend the range of the fishing area to:

<u>1st choice</u>	<u>2nd choice</u>	<u>3rd choice</u>	<u>4th choice</u>
5° x 5°	5° x 10° or 10° x 5°	10° x 10°	10° x 20° or 20° x 10°

Q *How do I find the coordinates of a 5° x 10° area ?*

A: We already know how to deal with an area defined as: 5° (latitude) x 5° (longitude). So what can we do if the area is enlarged to a 5° (latitude) x 10° (longitude)? We know how to calculate the coordinates for the latitude. We do exactly as before. To calculate the coordinates for 10° of longitude, we can also follow the same method, but we need to expand the number line. Find the first number, ending in zero only, that is immediately before and after the longitude degree number.



To find a $5^\circ \times 10^\circ$ area:

Example: Fishing position: $08^\circ 39.287 \text{ S } 168^\circ 27.246 \text{ E}$

Find the first number ending in a zero or 5, that is immediately before and after the latitude degree number and then, find the first number ending in a zero that is immediately before and after the longitude degree number.

Latitude:

08° : 4 5 6 7 **8** 9 10 11

has the coordinates **$5^\circ\text{--}10^\circ \text{ S}$** .

Longitude:

168° 160 161 162 163 164 165 166 167 **168** 169 170 171

has the coordinates **$160^\circ\text{--}170^\circ \text{ E}$** .

Therefore the coordinates of your $5^\circ \times 10^\circ$ area are: latitude $5^\circ\text{--}10^\circ \text{ S}$, and longitude $160^\circ\text{--}170^\circ \text{ E}$.

And finally:

Q: How do I find the coordinates of a $10^\circ \times 20^\circ$ area ?

A: We already know how to deal with an area defined as: 5° (latitude) \times 5° (longitude). We have also learned how to deal with an area defined as 5° (latitude) \times 10° (longitude). So what can we do if the area is enlarged further to 10° (latitude) \times 20° (longitude)? To increase the area to a $10^\circ \times 20^\circ$ area extend your search on the number line. Follow the example below.

To find a 10° x 20° area:

Example: Fishing position **17° 21.921 N 133° 34.213 W**

Find the first number ending in a zero that is immediately before and after the latitude degree, then find the number ending in a zero which is immediately before the longitude number. Next go further along the number line until you find the second number ending in a zero, which is after the longitude degree number.

Latitude:

17°: 9 10 11 12 13 14 15 16 **17** 18 19 20 21
has the coordinates **10°–20° N.**

Longitude:

133°:
128 129 130 131 132 **133** 134 135 136 137 138 139 140 141 142 143 144 145
146 147 148 149 150 151
has the coordinates **120°–140° W.**

**Therefore the coordinates of your 10° x 20° area are:
latitude 10°–20° S, and longitude 120°–140° W.**

Spotting the 5° x 5° area quickly

Using the examples set out above you should be able to get the 5° x 5° area for any fishing position. Still there is a bit of work involved if you have to follow these examples line-by-line, every time. With experience you may be able to spot the 5° x 5° fishing area for a fishing position quickly.

For instance:

Can you spot the 5° x 5° fishing area for these fishing positions quickly?

- 1) 13°32.456 N, 124°43.736 W
- 2) 05°12.352 N, 157°16.354 W
- 3) 18°32.422 S, 119°12.423 E

Answers:

- 1) 10°–15° N, 120°–125° W
- 2) 05°–10° N, 155°–160° W
- 3) 15°–20° S, 115°–120° E



Choices

Samplers are asked to only sample wells where the sets have the same:

- school association,
- calendar month,
- 5° x 5° area.

Sometimes the unloading wells will not fulfil these sampling criteria. If you cannot find such a well then we allow you to broaden your search to:

- *the same school association*

✓ **2nd choice:** None

There is no second choice for school association. All the fish in the well must have the same school association.

- *the same calendar month*

✓ **2nd choice:** It is okay if some of the fish in the well were caught up to seven days

before or seven days after the main calendar month.

- ✓ **3rd choice:** Samplers can choose wells where were caught during the same quarter.

1st quarter = January to March.

2nd quarter = April to June.

3rd quarter = July to September.

4th quarter = October to December.

- *the same 5° x 5° area*

✓ **2nd choice:** 5° x 10° area (or 10° x 5°)

✓ **3rd choice:** 10° x 10° area

✓ **4th choice:** 10° x 20° area (or 20° x 10°)

As area is not a critical selection criteria we can broaden our choice a lot.

Other considerations which will help you choose an appropriate well

- Make sure that the vessel has actually recorded the well numbers on the logsheet. If they have not done so, get the fishery officer to return the logsheet to the captain immediately and ask that the well numbers are filled in before unloading starts.
- The best wells to sample are those that contain only one set. These will be easily identified as there will be only one well number recorded on the line and it will not appear anywhere else on the logsheet. Mostly, however, you will find that the wells will contain fish from more than one set and you will have to check the sampling criteria for the fish in the well.
- How long was the vessel's trip? Have a look at the logsheet to gauge the overall length of the vessel's trip. Vessels that have done a short trip (for instance, less than three weeks) will probably fulfil the selection criteria easily. They will most likely have caught all the fish in the same calendar month, have fished in the same area, and may have targeted just one school association type if the fish are plentiful. If the vessel has been out longer, you will need to pay closer attention to the selection criteria.
- Remember, there may be times when wells are being unloaded that you will not be required to sample.

- **The vessel's well plan**

Increasingly, purse-seine vessels understand the nature of the port sampler's job and provide the samplers with a vessel well plan. The vessel well plan can be a good quick guide to spotting which wells are appropriate for sampling. Wells with fish from only one set are easily spotted — only one date entry will be written on that well. These are good wells to sample, as the fish will definitely have the three criteria for sampling — the same school association, the same calendar month, and the same area.

You will also be able to quickly spot wells that have been filled with fish from many different sets quickly — there will be many date entries for that well. Don't ignore these wells but check the entries on the logsheets carefully. You should sample them if they meet the selection criteria. Sampling will be biased if we only ever sample wells with fish from one set.

Remember, the vessel's well plan is only a guide. Ultimately you will have to use the logsheet to check whether a well is suitable for sampling. If the vessel's well plan and the vessel logsheet show different information *you should be guided by the information on the logsheet*. Report any inconsistencies in your report.

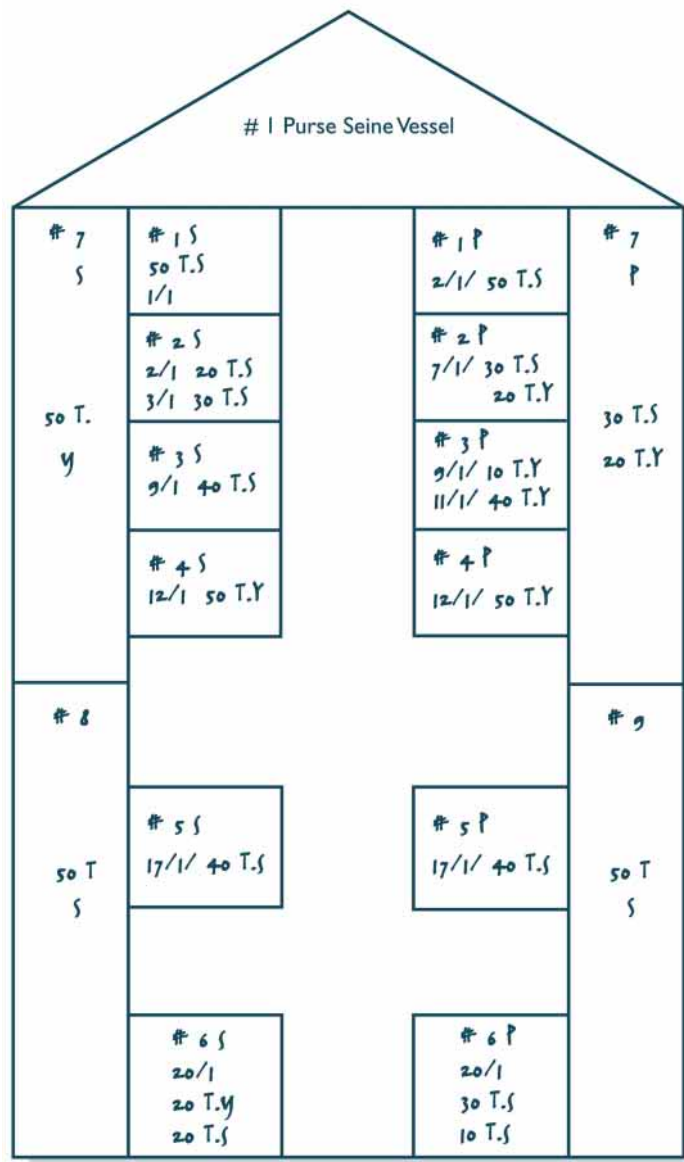

Vessel Well Plan

Example of a vessel well plan, as supplied by purse seiners.

- Another help for port samplers is the South Pacific Regional Purse Seine Well Loading Worksheet. This allows you to transcribe all the details from the logsheet to one sheet. You may find it easier to select appropriate wells from this sheet.

Sampling methods

Before you start sampling

Before you start sampling you must transcribe **completely** the line(s) from the logsheet which you have highlighted, onto your port sampling form. Remember this includes **all the well numbers** that were written on the logsheet, not just the well number you are sampling. This is outlined in the step-by-step guide provided on page 64.

Once you have selected an appropriate well and transcribed the logsheet information, you can begin sampling.

Sampling

There are three important items you must record on your sheet before you start measuring fish.

1. Fill in the header details.
2. Write down the name and number of the well you are going to sample. Use the small box on the top right-hand-side of the sheet to fill in the well number that you will sample. Usually there are between 30 and 60 metric tonnes of fish in a standard well. Only one well number should appear here. Then fill in the total weight of the fish in the well. You may be able to get this information from the vessel well plan or by asking the captain.

N.B. Record all weights in metric tonnes (MT)

SAMPLED WELL	
WELL NUMBER:	
WEIGHT OF FISH IN WELL:	

3. Indicate your sampling strategy. There are two sampling strategies. You must choose one. A tick box to indicate your intended sampling strategy is displayed on the top left-hand-side of your sheet.

SAMPLING STRATEGY (very important)

Please tick correct box	<input type="checkbox"/>	RANDOM SPECIES - species composition and length frequency sample
	<input type="checkbox"/>	NON-RANDOM SPECIES - length frequency sample only

- Samplers should *always* aim to do a random sample.
- Experienced samplers may be directed from time to time by their supervisor to do a non-random sample.
- Tuna which have been **pre-sorted** into species groups before sampling can be sampled by non-random sampling.

1. Random sampling

SAMPLING STRATEGY (very important)

Please tick correct box	<input checked="" type="checkbox"/>	RANDOM SPECIES - species composition and length frequency sample
	<input type="checkbox"/>	NON-RANDOM SPECIES - length frequency sample only

Where there is no pre-sorting of fish by the vessel, a random sample is one in which the port sampler does not pre-select his next fish, but follows a set sampling routine. Fish are not selected due to their size, colour, or species.

Random sampling is not complicated but some important aspects must be considered. It is only human nature to be distracted by the one small skipjack that passes by after you have measured a hundred large yellowfin. *But* if you were to pick



Fish should not be selected due to their size, colour or species.

up that skipjack you would not be doing a random sample. There are a few methods to overcome this problem. Select one at the start of the day and *stick with it*. That way you will have a truly random sample.

Some suggested random sampling methods:

- Select an area of the net, preferably an area close to you, and grab *all the fish* whose tails point towards you; or
- Select a small area of the net and take *all the fish* that land there; or
- Select an area of the net and grab *all the fish* whose heads point towards you.

Never allow fishers to help you with the sampling. It is difficult to explain your sampling protocol to them. They may hand you a fish with a pre-conceived notion of what you are trying to achieve. Typically fishermen will present you with the biggest or, in jest, the smallest fish that they have seen that day. Do not sample these fish. (It might pay, in an effort to keep relations positive, to pretend to measure them but do not write these measurements down.) Only record fish that have been selected according to your random sampling method. And, yes, this means that if any bycatch species are taken while you are sampling you should measure them and make a record.

2. Non-random sampling

SAMPLING STRATEGY (very important)

Please tick correct box	<input type="checkbox"/>	RANDOM SPECIES - species composition and length frequency sample
	<input checked="" type="checkbox"/>	NON-RANDOM SPECIES - length frequency sample only

While random sampling is the norm, there are two occasions when samplers should do non-random sampling:

- Experienced samplers may be directed by their supervisor to do a non-random sample.
- Pre-sorted tuna – tuna that have been sorted into species groups before the port sampler begins sampling — can be sampled with a non-randomly.

Experienced samplers may be directed to sample only one tuna species from the well ignoring all other species.

For instance, you may be directed to only sample only yellowfin tuna. You should continue to select the yellowfin randomly. This means that you must not be persuaded to measure just the large yellowfin. Follow the suggested sampling methods as outlined below, but substitute the name of your nominated species for the word ‘fish’, i.e.

yellowfin. Continue sampling until you have sampled 150 fish. If it is not possible to sample 150 fish, sample as many of the nominated species as you can.

Pre-sorted fish

If the vessel has pre-sorted the fish into species groups before you can sample them, you can do a non-random sample. Sample each pile of species, being careful not to select fish due to their size. Use the sampling method outlined below. Continue sampling until you have sampled 150 fish.

Suggested sampling method for a non-random sample: Randomly select your nominated species, ignoring all other species which might come to hand. Be careful not to select fish of your nominated species because of their size or colour (brightness etc.)

Example: targeting yellowfin:

- Select an area of the net, preferably an area close to you, and grab all the yellowfin whose tails point towards you; or
- Select a small area of the net and take all the yellowfin, that land there; or

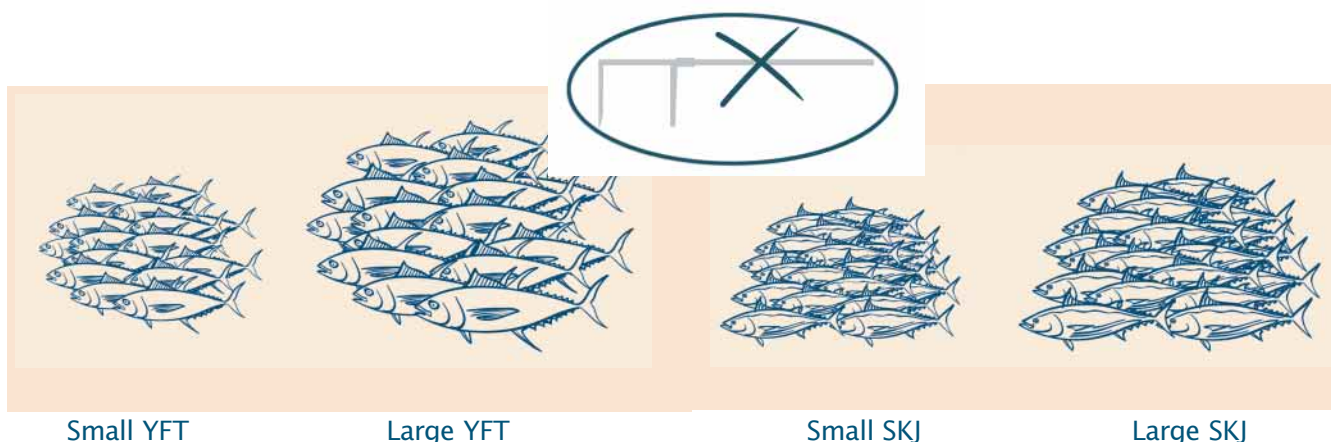

Small YFT

Large YFT

Small SKJ

Large SKJ

Do not sample fish that have been pre-sorted by both size and species.



- Select an area of the net and grab all the yellowfin whose heads point towards you.

Non-random sampling for bigeye tuna

If you are directed to do a non-random sample of bigeye tuna it is likely that the overall numbers of bigeye will be low, so we suggest that the best protocol is to measure every bigeye you see.

When not to sample

If the vessel pre-sorts the fish into loads that are separated by both their species and size (i.e. the large yellowfin are separated from the small yellowfin) then do not sample. Explain calmly, if questioned, that you are not required to sample these fish.

The practicalities of sampling

Each boat is different and samplers will have to decide where they want to stand to do their sampling. The wet deck is often better, as it is easier to verify which well the fish are being unloaded from and it is also possible to stand out of the sun. The main disadvantage of the wet deck is that you may or may not have good access to the fish. The alternative is to sample from the top deck or fishing deck. If you sample from this position, make sure you can confirm that the net of fish you are sampling is coming from your chosen well.

1. Samplers should aim to sample **5** fish from every net moved between vessels. This will depend on the vessel and the amount of cooperation given to port samplers. If this is difficult, you could try to sample between 10 and 20 fish from every second or third net that is moved. Try to establish one method

and follow it throughout the unloading session. This will make things easier for the unloading crew.

2. Try to establish a good working relationship with the unloaders and the winch master, in particular. If you are having problems getting time to sample, keep your cool and try to sort them out as quickly and as calmly as possible with the captain or whichever officer is in charge. You could point out that the more cooperation there is, the faster the whole operation will go. Samplers must work hard and fast and not hold up the operations any more than necessary.
3. **Collect new fish from each net first.** Then throw the sampled fish back. This avoids measuring the same fish twice. Take care not to mix them on deck also.
4. Record all bycatch species that are selected during random sampling.
5. **Continue sampling until the well has been completely emptied.** Sampling throughout the well will help compensate for any natural size gradients that may occur.

Species identification for purse-seine port sampling

Yellowfin tuna (*Thunnus albacares*) 30–45 cm

YFT

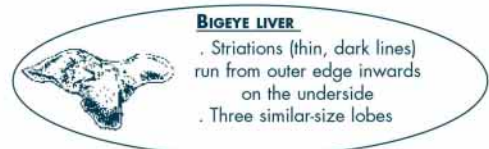
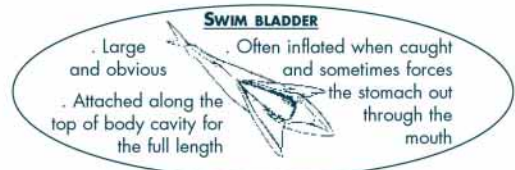
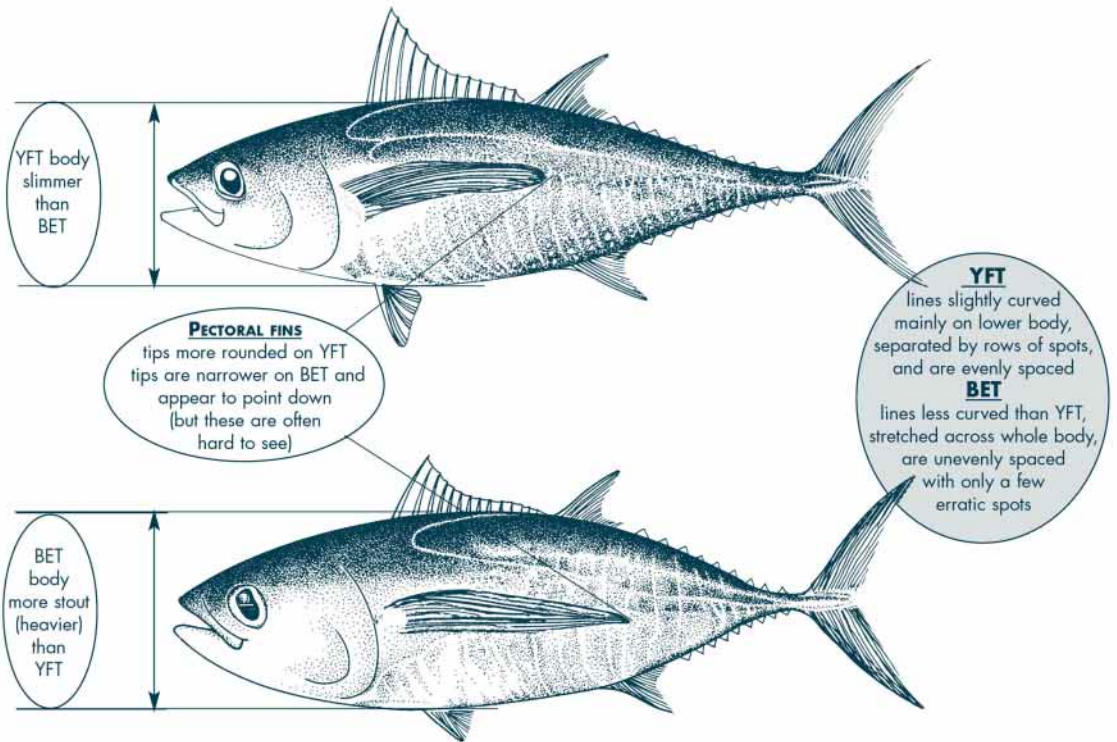
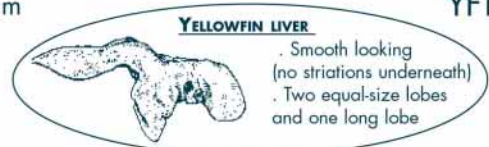



Chapter 5: Port Sampling Pole-and-Line vessels



Aim: To record the total weight of the catch and to randomly sample the entire catch, before sorting occurs, if possible. And if

sorting occurs, to record the size class of the sampled catch.

Most pole-and-line vessels based in the Pacific are domestic vessels and the majority are based in Solomon Islands. A number of other domestic vessels do exist, but their numbers are low. These vessels are supplemented by distant water pole-

and-line vessels that operate in the Pacific, but for the most part these unload their catch back into their home port.

How to carry out pole-and-line port sampling

1. Record the fishing details

With a copy of the vessel's logsheet, you will be able to record all the relevant fishing details. Make sure you remember to record the vessel's name and the date of your sample. Scan the fishing positions on the logsheet and record the fishing area. We have already shown you how to do this on page on page 11.

TICK ONE BOX BELOW		SKJ	YFT	BET	YFT & BET	MIXED TUNA	DOL	SIZE SORTED FISH SIZE CLASSES
<input type="checkbox"/>	Not sorted before sample	-						
<input checked="" type="checkbox"/>	Sorted by species only	4,763	1,101				120	Eg: 3 to 6 kg
<input type="checkbox"/>	Sorted by size and species	-						1
Record weight of each species landed. Record size class of sorted fish at right.		-						2
		-						3

2. Record the catch details

Before you start sampling you need to record the catch details. Tick the relevant box to indicate the type of sorting which took place before sampling. In the example above, the fish were sorted by species only. You should always aim to sample the catch **before** it is sorted. It may not be possible to always sample the catch before sorting occurs, but make sure your tick indicates which, if any, type of sorting took place before you sampled. It doesn't matter if the catch is sorted by the crew *after* you sample.

Once unloading has finished, you can ask the company for the total weight of the unloaded catch. Record the total unloaded weight of the catch on the same line that you ticked to indicate sorting. Finally, if size sorting has occurred, use the 'Size Sorted Fish Size Class' heading, on the right-hand-side, to record the weights of the fish in each size class.

- i.e. 1 = 1–3 kg
 2 = 4–7 kg
 3 = 7–12 kg

3. Sampling

For a non-sorted catch

Sample the unloading catch randomly until you have sampled at least 150 fish. In reality this usually means randomly taking a small basket of fish and measuring all the fish in the basket. Try to spread your sampling across each of the wells and throughout each well. This will compensate for any size-gradient sorting that may have occurred while the fish were in the well. Sampling a catch randomly means you must select the next fish to be measured without prejudice to its size, colour, or species. One way of producing a completely random sample would be to sample every fourth or fifth small basket that is removed from the well, and to measure every single fish in the basket. If any bycatch species come to hand while you are doing a random sample, record them on your form.

For a sorted catch

Sorted by species only

Sample each species of fish, randomly (see page 40) until you have 150 sampled fish.

Sorted by size and species

You should have already recorded the range of the weights in each of the size classes on your sampling form. Now indicate, with the size class number, which of the size classes you are about to sample. Place the number at the top of each column heading. Sample between 50 and 100 fish for each of the different size classes. Use two or more columns for each size class if necessary.



Chapter 6: Port Sampling Longline vessels

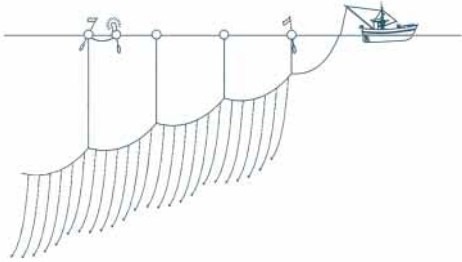

Aim:

- For longline sashimi vessels: The aim of the sampler is to identify and to record the length measurements of every fish that is unloaded and, where possible, to enumerate all other fish that are not presented for unloading.
- For longline freezer vessels: The aim of the sampler is to identify and to record the length measurements of 150 randomly sampled fish that come from an identified time–area strata.

The two grades of longline vessels are defined as:

Sashimi grade vessels: These longliners generally fish for no more than three weeks; they off-load fresh fish, which are generally air-freighted to their final destination.

Freezer grade vessels: These longliners fish for anywhere up to six months; they off-load frozen fish, which are generally shipped by carrier vessel to their final destination.

Sampling protocols

Sashimi grade vessels – sampling protocol

Every fish onboard should be recorded. This should be done by measuring every fish that is unloaded and by counting any other fish that is not presented for unloading or is retained onboard. Samplers need to go onboard the vessel every time to confirm if any fish have been kept onboard. Vessels in this category will mostly unload all their fish during just one session but be aware that sometimes they may unload fish for different markets at different times. You should be present for the entire unloading — even if it happens on separate days.

Freezer grade vessels – sampling protocol

Freezer grade vessels unload large numbers of tuna and so measuring every fish is difficult. Samplers should try to identify fish that were caught in the same 5° x 5° area and the same calendar month. In practice, this means identifying the fishing area and date of capture of the catch in each the hatches. Use the vessel's logsheet to identify the vessel's fishing area. You may also need the help of the fishing master and perhaps, for interpretation, the vessel representatives, to identify the fishing area where the fish in each of the hatches were caught.

If you cannot find a hatch containing fish from the same 5° x 5° area and caught in the same month you can broaden your search to:

Fishing area:	1 st choice	2 nd choice	3 rd choice	4 th choice
	5° x 5°	5° x 10°	10° x 10°	10° x 20°
Fishing month:	1 month	1 quarter*		

(*The 4 quarters of the year are outlined on page 37)

You may find it easier to measure the first fish that are off-loaded. These are often the last fish to be caught and identifying the area they come from may be simpler. Still, whenever possible, sample other blocks of fish, so as to reduce any bias that may occur from always sampling the first fish to be unloaded.

Randomly sample 150 fish from the block of fish you have identified.

Recording fish that are counted but not measured (sashimi grade vessels)

Record these fish on the main part of the form by using the length code NM (not measured). You can do this quickly and effectively by using a line or the repeating symbol (ditto) to show repeating species and length codes.

Write out the codes in full at the start and at the end of recurring data.



Be careful when you use a line or a symbol to show a repeating value. Many longline port sampling errors are caused by this. Write out the full code at the start and then again at the end, of each repeating data.

SPECIES	LENGTH		WEIGHT		EXPORT CODE	OTHER
	CM	CODE	KG	CODE		
YFT	123	UF			JP	
YFT	120	UF			JP	
YFT	109	UF			JP	
YFT	143	UF			JP	
ALB	—	NM			AS	
					AS	
					AS	
					AS	
					AS	
					AS	
					AS	
ALB	—	NM			AS	
TST	—	NM			LO	
					LO	
					LO	
					LO	
					LO	
					LO	
TST	—	NM			LO	
SHF	—	—	79	SF	OT	



Completing the form

The comment box

N.B.: CIRCLE "Y" OR "N" TO ANSWER		Eg: <i>FSH</i> 100 = 6		RECORD COUNTS OF FISH NOT SAMPLED and other COMMENTS
WERE ALL THE YFT, BET AND ALB UNLOADED AND ALL SAMPLED ?	<input checked="" type="radio"/> Y <input type="radio"/> N	TST = 3 , DOL = 4	Shark trunks - spp = 12 Shark fins = 23.5 + 14 kg	
WERE ALL SWO, MLS, BLZ, BLM AND SFA UNLOADED AND ALL SAMPLED ?	<input checked="" type="radio"/> Y <input type="radio"/> N			

The comment box is an area where you can indicate if you have been able to sample all the fish that were on the boat. You are required to answer two questions: Basically these mean: Were all the tuna and billfish unloaded? Did you measure all of the unloaded tuna and billfish?

Some samplers are intimidated by these questions and wonder if we are asking if they have done all their work! That is not the intention. By answering these questions we will know whether your sampling reflects the total catch of the vessel or not. Eventually your sampling efforts will be matched to the vessel's logsheets. If you answer 'Yes' (that all the tuna and billfish have been unloaded and all have been measured), we would hope that the number of fish you record is the same as the number of fish that the vessel notes on their logsheet. Obviously, in some cases, especially with frozen grade vessels, you will not be able to measure all the fish.

If you mark 'N' ('No'), you should make a comment and explain why you have not measured all the fish.

Comments may include: *'Frozen grade longline vessel — only measured 150 fish'* or *'Some of the billfish were kept back to be unloaded to the ware-*

house later' or 'Some fish kept onboard for crew consumption'.

The comment box also provides an area for you to tally fish that you have not been able to measure. In some instances where large numbers of albacore are being removed continuously but not measured, it may be good to keep a tally going. You should aim to record all the fish; from the vessel on the main part of the form just use the NM code (not measured). Put a line through your tally once you have transferred the information, so you won't be tempted to transfer the data a second time. Also, if you have forgotten the three-letter FAO code you can record the fish in the comments box, e.g. 'three breams'.

Shark fins

You should make a determined effort to record the number of shark fins that are unloaded from the vessel. This can be done in a number of ways. You can use the species code SHF (Shark fin) to record the total weight of the shark fins. You will also need to use the weight code (SF) (Shark fin). You can also use the comment box to record the total number of shark fins unloaded. Be clear about what you record. Shark fins are often unloaded in 'sets' of 4 fins from one shark (*i.e. one set is the dorsal fin, two pectoral fins and the lower caudal fork fin*). If you

record groups of shark fins, state this in the comment box, ‘i.e. 75 sets of shark fins’ or ‘300 individual shark fins unloaded’.

Collecting weight information

Sampling sashimi grade vessels is often a great opportunity to get weight data of the commercial catch. In fact, it is one of the few opportunities that we have to get weight data for individual fish. Generally, observers are unable to get weight data because there are no weighing scales onboard the vessels. Where possible, samplers should collect a weight measurement along with the length measurement of the fish. For a full explanation of weight measurements see page 26.

Weight measurements should be collected in addition to length measurements.

*Do not collect weight measurements **only**.*

Export code

Information on the final market destination of the fish is often freely available in the packing area. Samplers are asked to collect this information, as the market destination of the fish may influence the fishing strategy or the type of species targeted. County codes for the most common countries are listed on the back of the forms.

‘Other’ column

The ‘other’ column is blank and can be used as needed. You may have collected a tag from a

fish and can mark that information here. You may also be asked to collect biological samples from fish and so could mark the sample number here. Do not mix data. If you use this column, only record the same type of data throughout each sheet. Label the top of the column with the name of the data you are collecting (e.g. tag number, sample number).

Sum of lengths

At the bottom of the longline port sampling form there is an area where you are requested to add up the total number of fish by species and the sum of the total lengths by species, on each sheet. By doing these additions, port samplers will help speed up data entry.



Species identification for longline port sampling

Black Marlin (*Makaira indica*)

BLM

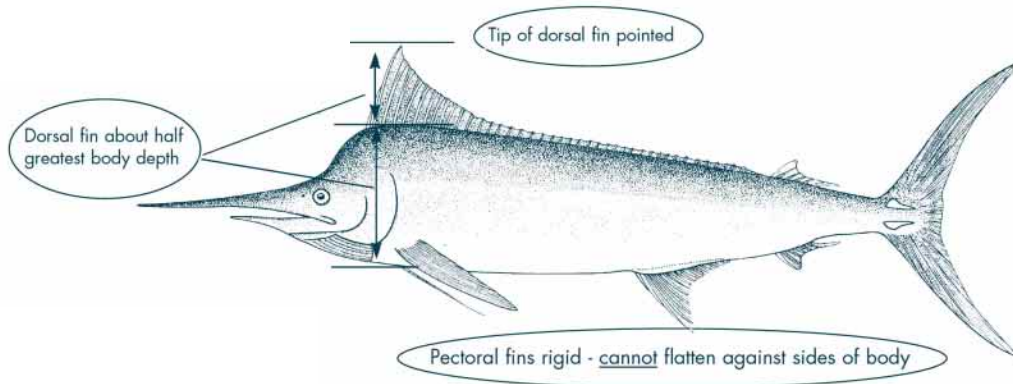

Blue Marlin (*Makaira mazara*)

BLZ

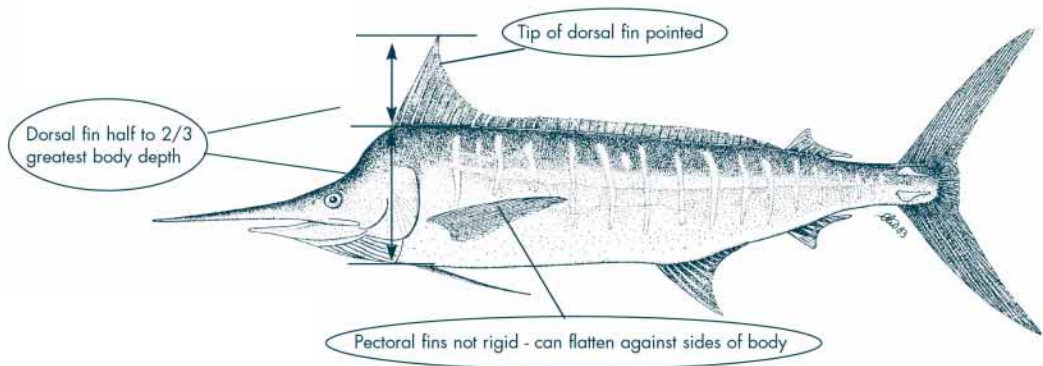

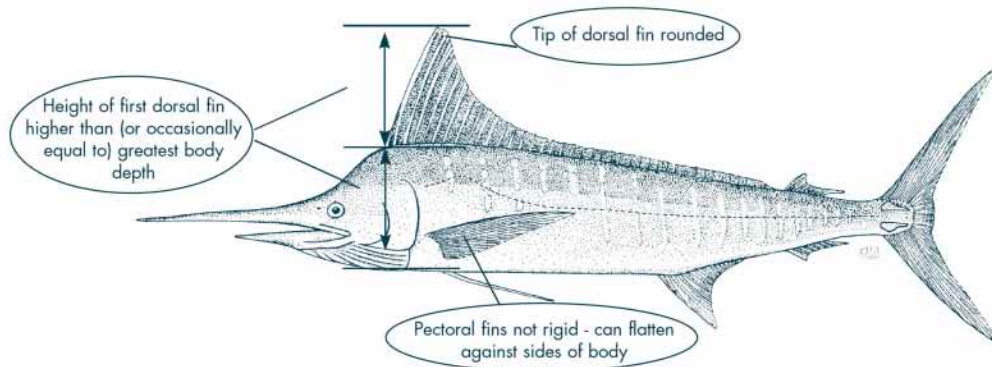

Striped Marlin (*Tetrapturus audax*)

MLS



Dressed marlin

Feature	Black	Blue	Striped
Pectoral fin shape			
Scales	Deep, but clearly seen	Obvious under skin	Deep in skin
Colour of Flesh	Pinkish white/grey	Pinkish white/grey	Distinct orange colour
Second dorsal and second anal fin alignment	The second dorsal fin is in front of the second anal fin.	The second dorsal fin is behind the second anal fin.	The second dorsal fin is behind the second anal fin.
Height of first dorsal fin when erect.	About half the greatest the body depth.	About half to 2/3 the greatest body depth	Higher than (or equal to body depth)

Species identification on frozen grade longliners

Fish unloaded from frozen grade longliners are often frozen solid and heavily processed (the head and /or the tail may be cut off), making it hard to identify them. Port samplers should only write down species codes they are sure of. For instance, don't write down 'YFT' for yellowfin if you are really not sure if it is a yellowfin a bigeye, or a bluefin tuna. Group codes may be helpful in this case, i.e. TUN (see page 9 for other group codes). Avoid incorrect species codes — a group code or the unidentified fish code 'FSH' is a better option.



Chapter 7. Other Things To Consider

Recovering tags

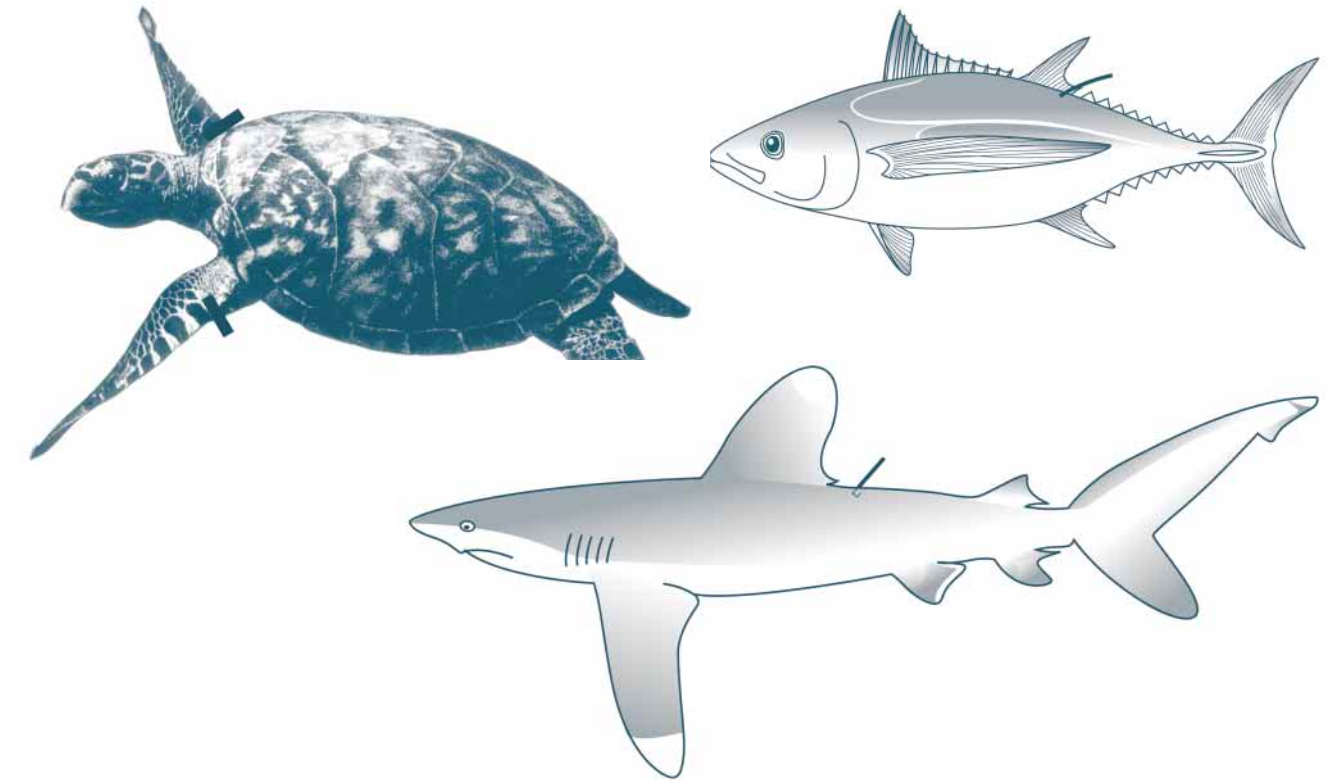

Every once in a while, a tagged fish comes along. Fish and marine mammals are often tagged so scientists can understand both their movement and their growth. SPC's last big tagging programme may be over, but many of the tags are still out in the ocean. The SPC tags are supplemented by tags from many other organisations on a wide range of different species of fish and marine mammals. Many of the larger tagging programmes use the traditional small plastic 'dart' tags and reward the finder with caps, t-shirts, or small sums of money. Now, with technological advances, more sophisticated tags are being used. These

record the depth, temperature and position of the tagged fish and transmit the data to satellites. Two types of tags exist. Archival tags are stitched inside the body of the fish and a long trailing 'tail' is left outside the fish, making them easy to spot. Pop-up tags are attached to the outside of the body of the fish. They are programmed to detach from the body of the fish and transmit their information via satellite at a pre-determined date or depth. Since they detach, they will rarely, if ever, be seen by port samplers. Because of the investments involved, archival tags rewards are considerably larger than the traditional tag rewards.

What to do if you find a tagged fish

If you find it yourself

If you spot a tag on a fish, remove the tag and record the details as listed below. Forward the tag and the details to the address marked on the tag. It is best if you staple the tag to a piece of paper before you place it in an envelope. That way it is less likely to get lost. You should receive a reward for the tag.

If a fisher finds a tag

If a crew member alerts you to a tag they have found, try to record as many details as possible about the tag. Encourage the fisher to forward the tag to the marked address with all the relevant details, as outlined below. At the same time you should send the details of the tag to the marked

address as well — in case the fisher forgets to do so. Enclose the fisher's name and address for the reward. This will encourage them to forward tags in future. And who knows, you may be rewarded for your vigilance as well!

Recording tag details

- *Record the tag number.*
- *Record the date of capture.*
- *Record the area of capture.*
- *Record the name and the gear type of the vessel.*
- *Record the length. Remember to state the length code.*
- *Record the fisherman's name and address.*
- *Record your name and address.*

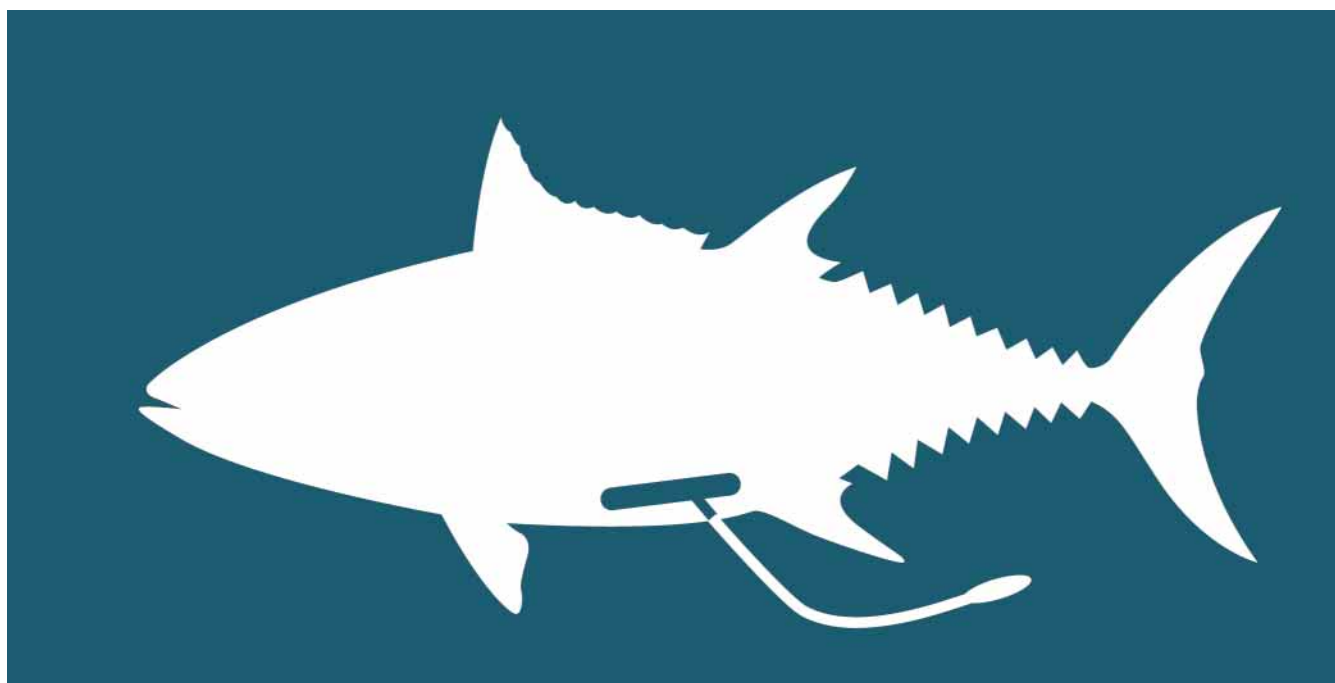

Port samplers found falsifying their data will have their contracts terminated immediately.



Remember it is better to have no data than false data

Monthly report

The most senior port sampler is required to fill in a monthly report. The report has two components:

- 1) a tally of the names and dates of the vessel unloadings during the month and
- 2) a written report.

Submit your monthly report to SPC at the end of each calendar month with your data sheets.

The monthly report has a dedicated column to mark submitted logsheets. If you are responsible for collecting logsheets in your harbour, you can keep a record of which logsheets have been submitted on the monthly report. Some logsheets may be submitted after the end of the month; for this reason you should keep a photocopy of your monthly summary and tick off the late logsheets as they arrive. You are not required to submit these photocopies but SPC may enquire about missing logsheets, so it will help if you know which logsheets have actually been submitted. The written reports will help document the evolving environment of each harbour; for instance, whether influenced by seasonal fishing, when and if new vessels join the fleet or if any leave, and if new markets have been accessed. A standardised monthly report is attached on page 67.

Reporting pollution

International marine pollution regulations control vessel discharge into the ocean. Port samplers should be aware that the International Convention for the Prevention of Pollution from Ships (MARPOL) states:

- Oil discharges greater than 15 parts per million (p.p.m) are prohibited. In practical terms this means that **any visible oil slick is illegal** and should be reported.
- The disposal of all plastics into the sea from vessels is prohibited.

If you see a vessel violating these laws you should, if possible, take a note of the incident and report it to the local port authorities or your fishery officer. The observer form ‘South Pacific Observer Pollution Report (Form GEN-6)’ can be used to record pollution incidents.

Falsifying data

Your data are checked for errors at SPC. They are also checked for any attempts to submit falsified data. In an unsupervised environment, falsifying data may seem tempting. In jest you may even be urged by fishers to do this. ‘Oh go on, just write down anything, who will know?’ But we will know. Your data are checked by computer. All graphed length frequency data should show the same general pattern. Remember the length-frequency graph on page 6? We can predict the average size of the fish you measure each month. Cross checking your length data with that from a neighbouring port is another way we can monitor the expected average length of your length-frequency data. So writing down ‘any old numbers’ won’t do. Samplers found falsifying their data will have their contracts terminated immediately. If you are having problems with your job — you cannot turn up to a sampling session for instance — discuss the problems with your supervisor.

Chapter 8: Reference Materials

Online resources

SPC's Oceanic Fisheries Programme website: [//www.spc.int/oceanfish/](http://www.spc.int/oceanfish/) has many resources for port samplers to click into. An electronic version of this manual will be available and a full set of the current standardised regional data collection forms are also available there. SPC publishes an observer and port sampler newsletter *Fork Length*, which keeps port samplers and observers informed of what is happening in the region. Current and back issues are also available.

The Oceanic Fisheries Programme also hosts in-country web pages on their website. Fishery data collected from each of the Pacific Island countries are accessible from these pages. Access to these pages is by password only. With permission from their supervisors, port samplers can access these web pages and access such information as the status of data processing – the date their data were received at SPC and the date they were entered into the database. Length-frequency graphs, by species, for each economic exclusive zone can also be accessed.

Should you wish to contact SPC about any matter relating to port sampling work, please send an e-mail to: portsampler@spc.int

References

Bailey, K. 1989. Port sampling protocol for sampling albacore, skipjack, and yellowfin tuna at PAFCO, Levuka. Tuna and Billfish Assessment Programme. South Pacific Commission Internal Report No 14. Noumea, Secretariat of the Pacific Community.

Labelle, M. Hampton, J. Bailey, K. Murray, T. Fournier, D. Sibert, J. 1993. Determination of age and growth of South Pacific albacore (*Thunnus alalunga*) using three methodologies. Fishery Bulletin 91:649–663. Noumea, Secretariat of the Pacific Community.

Lehody, P., J. Hampton and B. Leroy. 1999. Preliminary results on age and growth of bigeye tuna (*Thunnus obesus*) from the Western and Central Pacific ocean as indicated by daily growth increments and tagging data. Working Paper BET-2, Twelfth Meeting of the Standing Committee on Tuna and Billfish, Tahiti, French Polynesia, 16–23 June 1999. Secretariat of the Pacific Community, Noumea, New Caledonia.

Lehody, P., J. Hampton and B. Leroy. 1999. Preliminary results on age and growth of yellowfin tuna (*Thunnus albacares*) from the Western and Central Pacific ocean as indicated by daily growth increments and tagging data. Working Paper YFT-2, Twelfth Meeting of the Standing Committee on Tuna and Billfish, Tahiti, French Polynesia, 16–23 June 1999. Secretariat of the Pacific Community, Noumea, New Caledonia.

Pepperell, J. and P.A. Grewe. A field guide to the Indo-Pacific Billfishes. Australia: Commonwealth Scientific and Industrial Research Organisation (CSIRO).

Sharples, P. 2000. Pacific Community observer and port sampler I.D. sheet series 2000. Oceanic Fisheries Programme, Secretariat of the Pacific Community, Noumea. Unpublished.

Anonymous. 2000. Report of the Thirteenth Meeting of the Standing Committee on Tuna and Billfish, Noumea, New Caledonia, 5–12 July 2000. Secretariat of the Pacific Community, Noumea, New Caledonia.



Port sampling harbours

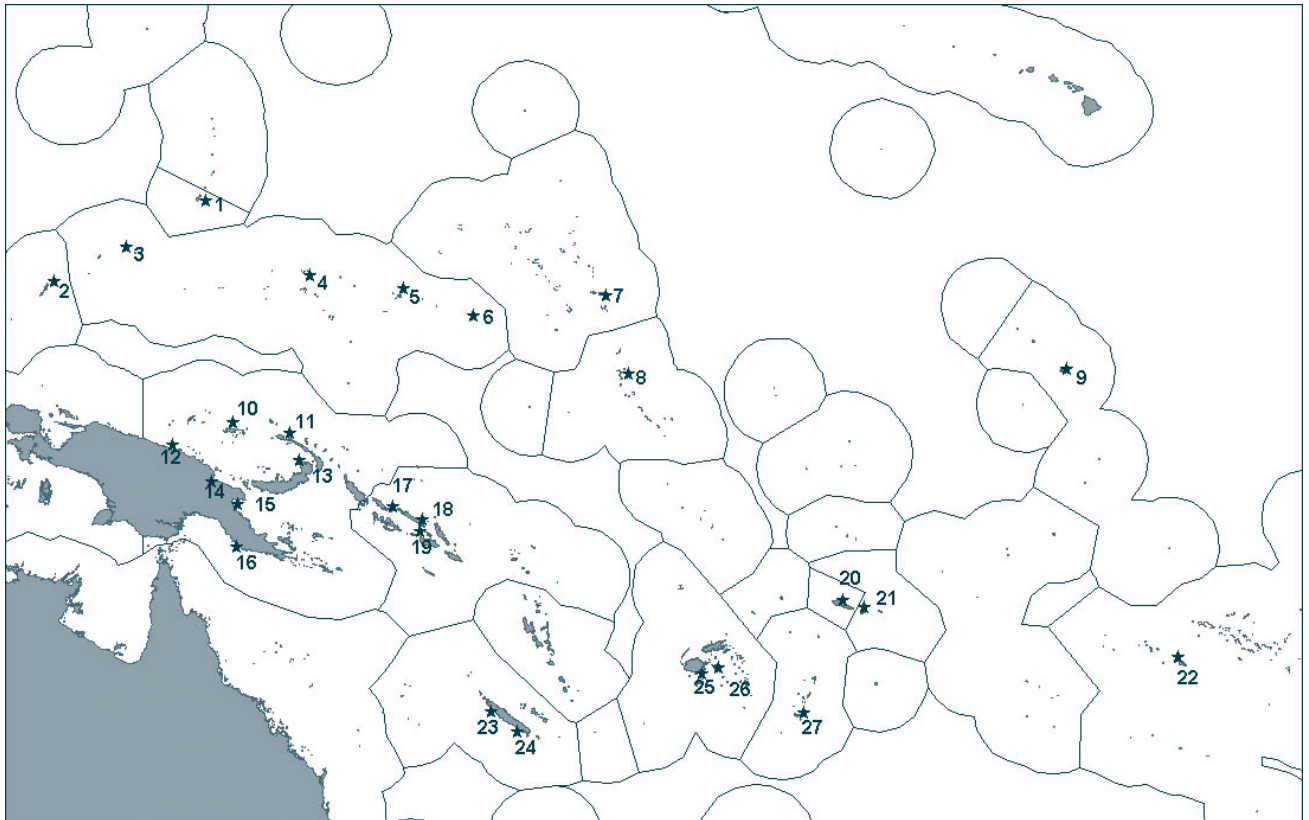

- | | | |
|---------------|------------------|------------------|
| 1. Guam | 10. Manus | 19. Tulagi |
| 2. Koror | 11. Kavieng | 20. Apia - Samoa |
| 3. Yap | 12. Wewak | 21. Pago Pago |
| 4. Chuuk | 13. Rabaul | 22. Tahiti |
| 5. Pohnpei | 14. Madang | 23. Koumac |
| 6. Kosrae | 15. Lae | 24. Noumea |
| 7. Majuro | 16. Port Moresby | 25. Lami - Suva |
| 8. Tarawa | 17. Noro | 26. Levuka |
| 9. Kiritimati | 18. Honiara | 27. Nuku'alofa |

A few words in another language

English	Japanese	Taiwanese	Korean	Filipino
Hello	Konnichi wa	Ni hao	An-nyong	Mabuhay
Goodbye	Say-o-nara	Zajkian	An-nyong	Paalam
Please	Dozo	Qing	Je-bal	Pakisuyo
Thank you	Arigato	Xiexie	Kam-sa-ham-ni da	Salamat
Yes	Hai	Repeat the verb	Ye	Oo
No	ie	Bu 'repeat verb'	A-ni-yo	Hindi
Good	Ee	Hao	Jo-a-yo	Mabait
Bad	Wah-roo-ee	Bu hao	Na-pa-yo	Masama
What time is it ?	Naji desuka ?	Shenme shihou ?	Myot shi im-ni-kka?	Anong oras ua?
My name is...	...to moshimasu	Wo xing...	Je irum un... im ni da?	Ang pangalan ko ay
Okay	Okay	Hao	Jo-a-yo	Okay
Where is the...?	..ha doko desuka ?zai nar ?eeo-di-seo-yo ?	Nasaan ang....?
How are you...?	Ofenki sesuka?	Ni hao?	Eeo-tae-yo?	Kumusta?
Fish	Sakana	Yu	Mul-go-gi	Isda



*Other regional standard length measurements
For rays only:*

TW

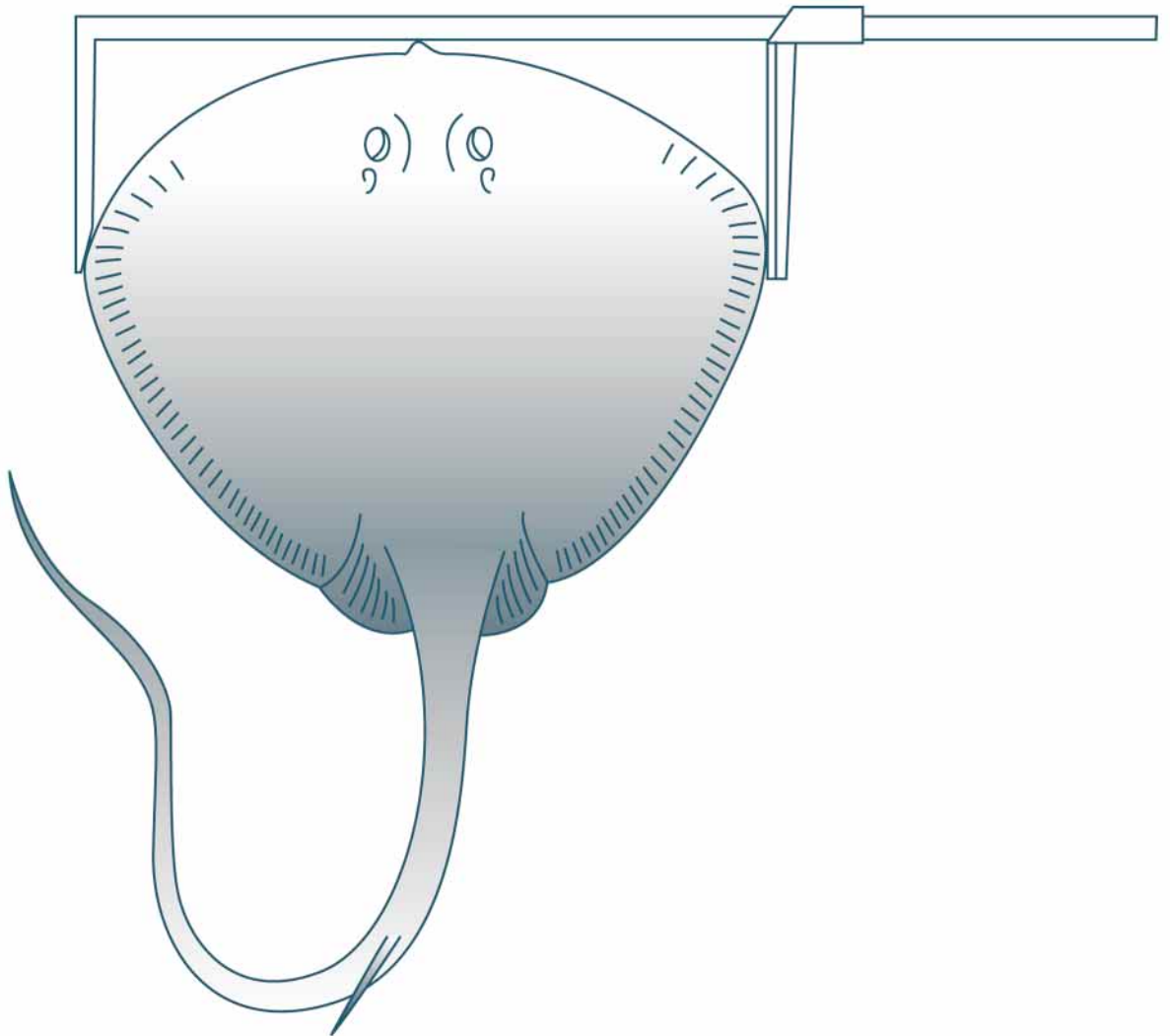

TW: Total width

*For turtles only
(This length code is only to be used with calipers)*

SCW

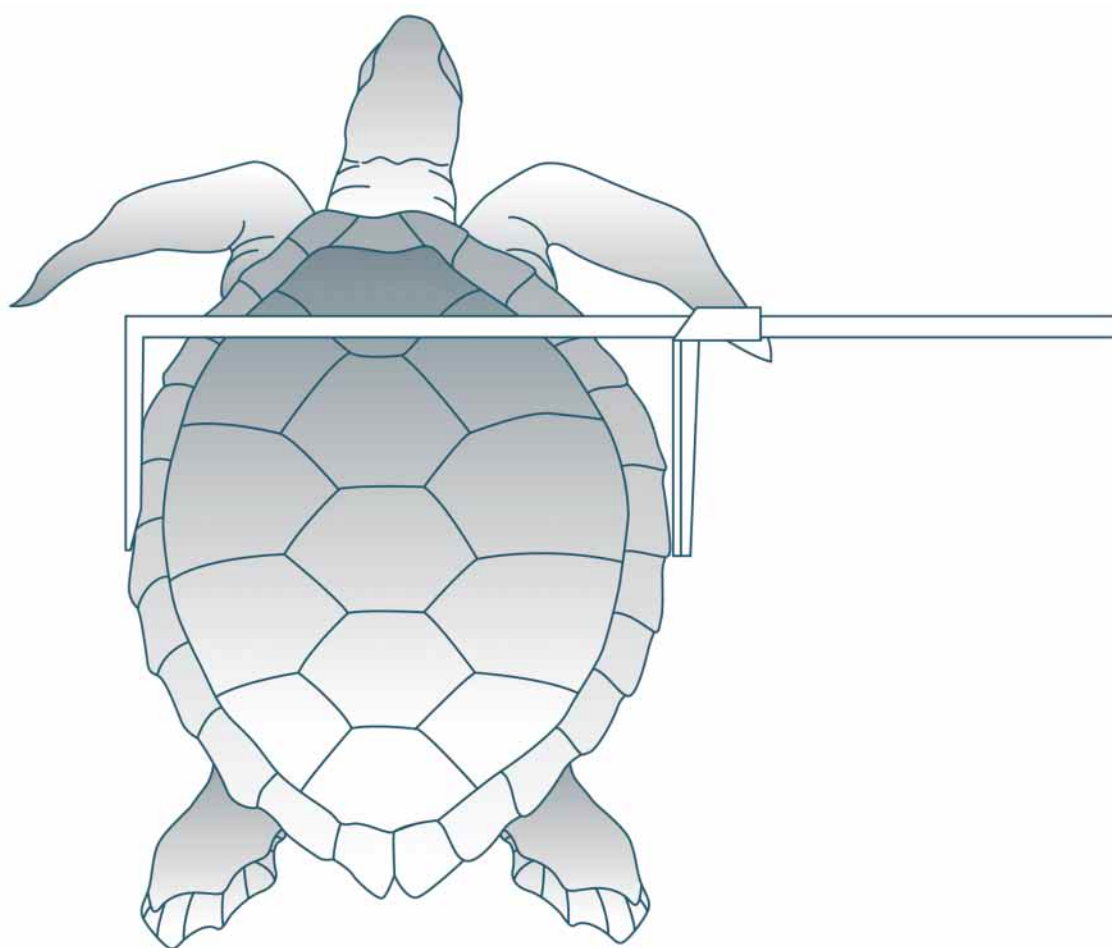

SCW: Straight carapace width



*For turtles only
(This length code is only to be used with calipers)*

SCL

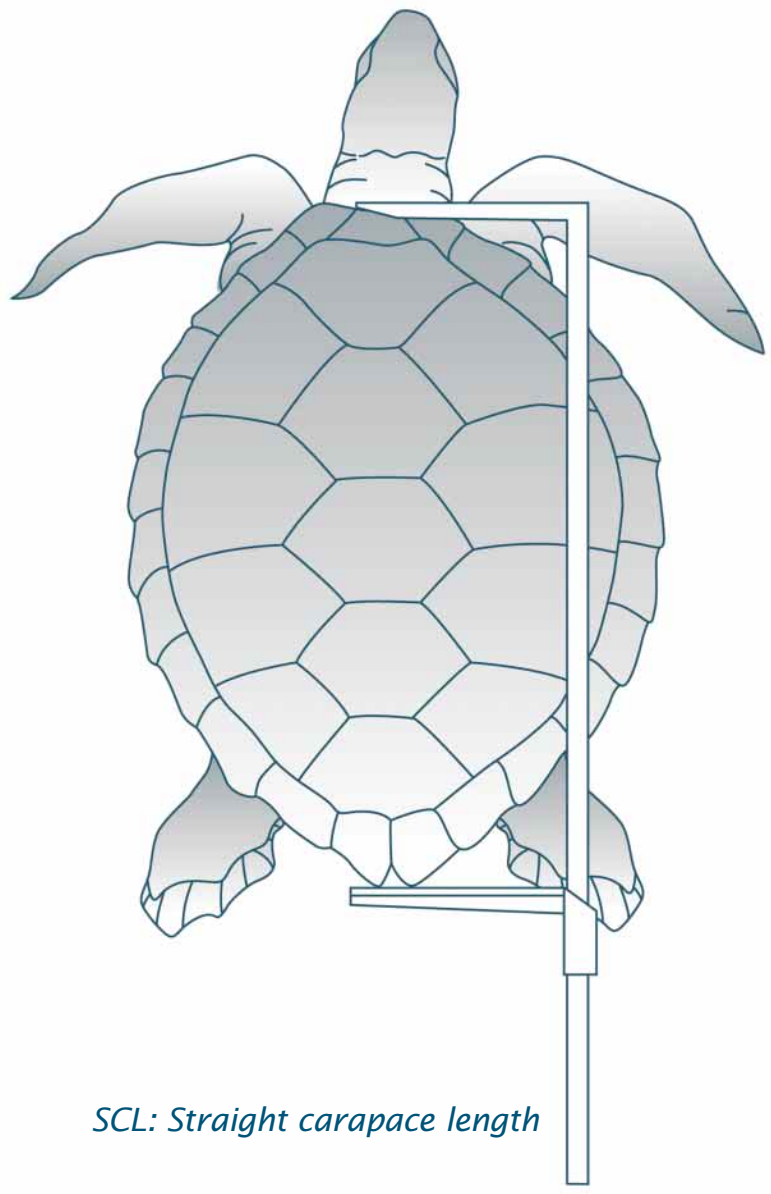

SCL: Straight carapace length

How to avoid common errors on longline sampling forms

SOUTH PACIFIC REGIONAL LONGLINE PORT SAMPLING FORM
REVISED AT REGIONAL FORMS COMMITTEE, DEC. 2000.

1. PORT: _____ SAMPLER: _____ ASSISTANT: _____ 2. PAGE _____ OF _____

VESSEL NAME: _____ COUNTRY OF REGISTRATION: _____ REGISTRATION NUMBER: _____

DATE - START OF TRIP (DEPARTED PORT) D D M M Y Y DATE - END OF TRIP (ARRIVED IN PORT) D D M M Y Y DATE OF SAMPLE: _____ 3. D D M M Y Y

FISHING AREA FROM LATITUDE N TO S FROM LONGITUDE E TO W

SPECIES	LENGTH CM	CODE	WEIGHT KG	EXPORT CODE	OTHER	SPECIES	LENGTH CM	CODE	WEIGHT KG	EXPORT CODE	OTHER
BET	101	UF	21.6	GG	JP	BET	121	← 6.			V?
BET	110	UF	27.2			BET	122				
YFT	111	UF	23.5			BET	127				
YFT	123		31.9			YFT	109				
YFT	113		24			YFT	89				
YFT	114		25			YFT	90				
YFT	121		30			DOL	107				
YFT	119		28			DOL	108				
YFT	127		35			DOL	111				
BET	109		27			DOL	123				
BET	108		26			WAH	129				
BET	141		58			WAH	119				
BET	143		60			WAH	124				
BET	131		46			MLS	172				
BET	137		53			BLZ	152	← 6.			
YFT	139		45			BLZ	159				
YFT	117		27		V	BLZ	154				
YFT	119		28		JP	TST	69				
ALB	120				AS	TST	72				
ALB	119		96.6	5.	AS	ALB	101				
ALB	111				AS	ALB	99				
ALB	107				AS	ALB	89				
MLS	197			6.	LO	ALB	119				
MLS	163			6.	"	ALB	103				
MLS	152				4	ALB	104				

N.B.: CIRCLE "Y" OR "N" TO ANSWER

WERE ALL THE YFT, BET AND ALB UNLOADED AND ALL SAMPLED? Y N 7.

WERE ALL SWS, MLS, BLZ, BLM AND SFA UNLOADED AND ALL SAMPLED? Y N

8. COMMENTS: _____

ALL SPECIES EXCEPT BILLFISH				BILLFISH			
LENGTH CODES		WEIGHT CODES		LENGTH CODES		WEIGHT CODES	
UF	UPPER JAW TO CAUDAL FORK	WW	WHOLE WEIGHT	LF	LOWER JAW TO CAUDAL FORK	GH	GUTTED, HEADED
US	UPPER JAW TO SECOND DORSAL	GG	GILLED & GUTTED	PF	PECTORAL TO CAUDAL FORK	GX	GUTTED, HEADED, TAILED
PS	PECTORAL TO SECOND DORSAL	GT	GILLED, GUTTED, TAILED	PS	PECTORAL TO SECOND DORSAL	GO	GUTTED ONLY, NOT GILLED
NM	NOT MEASURED	GX	GUTTED, HEADED, TAILED	NM	NOT MEASURED	NM	NOT MEASURED
		NM	NOT MEASURED				

2. SPECIES NUMBER: _____

SPECIES NUMBER	YFT	BET	ALB	SWS	MLS	BLZ	BLM	SFA	OTHER SPECIES
SUM LENGTHS									
SUM WEIGHTS									

1. Make sure you fill in all the header details on **every sheet**.

2. Fill in the page numbers per vessel sampled.

3. The vessel name and sampling date are critical fields. Make sure you fill them in.

4. Round up your weight measurement to the nearest centimetre.

5. Do not record multiple weights.

6. Remember, the length code must be clear for every fish. Be especially careful when you change from tuna to marlin.

7. Always answer these simple questions.

8. Use the comment box to explain why all fish have not been sampled.

9. Total the number of fish and the sum of their lengths – for each sheet.



How to avoid common errors on purse-seiner sampling forms

SOUTH PACIFIC REGIONAL PURSE SEINE PORT SAMPLING FORM

1. PORT: _____ SAMPLER: _____ ASSISTANT: _____ 2. PAGE OF _____

CARRIER OR CANNERY: _____ 3. VESSEL NAME: _____ COUNTRY OF REGISTRATION: _____ REGISTRATION NO.: _____

DATE AT START OF TRIP: (departed from port) D D M M Y Y DATE AT END OF TRIP: (arrived in port) D D M M Y Y DATE OF SAMPLE: D D M M Y Y

SET DETAILS (to be obtained from Vessel Logsheet)

MONTH	DAY	LATITUDE ddmm.mmm	N S	LONGITUDE dddmm.mmm	E W	SCHOOL ASSOC.	SET START TIME	SKIPJACK WEIGHT	YELLOWFIN WEIGHT	BIG EYE WEIGHT	OTHER SPECIES NAME	WEIGHT	WELL NUMBERS
4	4	01° 33	N	159° 32	E	1	0800	30					P5
4	6	01° 08	N	159° 36	E	1	1330	30					S5
4	8	01° 40	N	159° 51	E	4	0900	100					P4, S5, P5
4	9	00° 58	N	159° 39	E	1	0830						

SAMPLING STRATEGY (very important)

8. Please tick correct box: RANDOM SPECIES - species composition and length frequency sample NON-RANDOM SPECIES - length frequency sample only

N.B. Record all weights in metric tonnes (MT)

SAMPLED WELL: WELL NUMBER: P3, S3 WEIGHT OF FISH IN WELL: 100

SPECIES and LENGTH DATA

SPECIES CODE	LENGTH	SPECIES CODE	LENGTH	SPECIES CODE	LENGTH	SPECIES CODE	LENGTH	SPECIES CODE	LENGTH	SPECIES CODE	LENGTH
SKJ	53	SKJ	70	SKJ	58	SKJ	54	SKJ	54	BET	47
SKJ	43	SKJ	45	SKJ	70	SKJ	59	BET	59	SKJ	52
SKJ	55	SKJ	55	SKJ	68	SKJ	56	SKJ	56	SKJ	59
SKJ	60	SKJ	99	"	59	SKJ	58	SKJ	58	SKJ	62
SKJ	57	"	49	"	136	SKJ	69	SKJ	69	SKJ	49
YFT	66	"	64	"	71	SKJ	49	SKJ	49	SKJ	61
SKJ	65	"	65	"	143	SKJ	69	SKJ	50	SKJ	64
SKJ	61	"	65	"	48	SKJ	50	SKJ	74	SKJ	51
SKJ	58	"	46	"	72	SKJ	74	SKJ	48	SKJ	55
YFT	123	SKJ	68	"	44	SKJ	48	YFT	123	SKJ	58
SKJ	64	YFT	126	"	59	YFT	123	SKJ	67	SKJ	56
SKJ	47	SKJ	68	"	68	SKJ	67	YFT	12B	SKJ	53
SKJ	64	"	62	"	71	YFT	12B	YFT	72	SKJ	47
SKJ	62	"	57	"	67	SKJ	72	SKJ	65	SKJ	39
SKJ	58	"	60	"	63	YFT	65	YFT	53	BET	41
YFT	112	SKJ	59	"	65	SKJ	53	SKJ	60	SKJ	70
SKJ	53	BET	66	"	67	SKJ	60	SKJ	67	BET	72
SKJ	69	SKJ	51	"	130	SKJ	67	SKJ	40	SKJ	41
SKJ	54	SKJ	53	"	49	YFT	140	SKJ	66	SKJ	54
YFT	113	BET	41	"	53	SKJ	66	YFT	109	BET	72
SKJ	53	SKJ	59	"	56	YFT	109	YFT	63	SKJ	49
SKJ	50	YFT	46	"	67	SKJ	63	SKJ	60	SKJ	58
SKJ	119	SKJ	68	"	53	SKJ	60	SKJ	58	SKJ	56
SKJ	63	SKJ	44	"	58	SKJ	58	YFT	112	SKJ	56
SKJ	70	BET	53	"	96	YFT	112	SKJ	53	SKJ	59

DATA ENTRY VERIFICATION

	SKJ	YFT	BET	OTHER
NUMBER OF EACH SPECIES	10			
Σ LENGTHS FOR EACH SPECIES				

SCHOOL ASSOCIATION CODES

1 Unassociated	5 Anchored raft, FAD or payao
2 Feeding on baitfish	6 Live marine mammal
3 Drifting log, debris or dead animal	7 Live whale shark
4 Drifting raft, FAD or payao	8 Other

1. Make sure you fill in all the header details on **every sheet**.
2. Fill in the page numbers – per vessel sampled.
3. The vessel name and sampling date are critical fields. Make sure you fill them in.
4. Check that the school association of all the fish in the well is the same.
5. Record the well number of well that you sample. Only one well number should appear here.
6. Record the total weight of fish in the well. This is usually between 30–60mt.
7. Transcribe the logsheet details onto your sampling sheet in full. Don't forget the well numbers.
8. Remember to record your sampling strategy.
9. Be careful that you record the correct species code for every fish - especially when species changes.
10. Total the number of fish and the sum of their lengths – for each sheet.

A step-by-step guide to selecting wells for purse-seine port sampling

1. Secure a copy of the vessel logsheet, and if available, the vessel well plan.
2. Ensure the well numbers are recorded on the vessel's logsheet. If they are not, return the logsheet to the captain.
3. Find out which well will be unloaded next.
4. Check down the 'well numbers' column on the logsheet.
5. When you spot the well number for the well you want to sample, highlight it. Then highlight the entire line on the logsheet where that well number is written
6. You can now see the fishing details for the fish in the well clearly.
7. Check that the:
 - 1) school association,
 - 2) the position, and
 - 3) the calendar month
 of these fish meet the selection criteria.
8. If the selection criteria have been met, write out the highlighted logsheet entries in full, onto your port sampling form.
9. Then fill in the sampling strategy, the well number(s), and well weight on your port sampling form.

Example:

Step 3. The vessel decides to unload well S1.

Step 5. Highlight all the lines on the logsheet with well number S1.

MONTH	DAY	ACTIVITY CODE	SCHOOL OR WELL NUMBER					SCHOOL		SCT	RETAINED CATCH			DISCARDS										
			1 LETTER	2 LETTERS	3 LETTERS	4 LETTERS	5 LETTERS	#	ASSOC.		START	BANKSIDE	YH(L)WHM	WH-YS	OTHER SPECIES		WEIGHT	TOTAL WEIGHT			OTHER WEIGHT			
															PARS	BLNWT		WGT	PARS	BLNWT	CULC	PARS	BLNWT	BLNWT
S	1	200 10 267	S	105 01 190	I																			
S	2	200 05 408	N	104 08 054	F																			
G	3	204 21 984	N	103 04 072	E																			
S	4	100 20 296	N	105 02 190	S	2	350	40	20						175	S1								
S	6	100 05 207	N	100 04 753	F	2	1500	20							75									
G	0	108 45 112	N	103 02 700	E	2	900	10							45	P1								
S	9	104 28 894	N	105 04 420	S	2	1200	40							120	S1, S3								
S	9	103 10 346	N	103 05 030	I	2	1740	20	10						350	S1								
G	9	203 08 020	N	104 03 041	E																			
S	7	203 13 297	N	105 01 586	S																			
S	8	100 00 205	N	105 01 060	I	2	1945	20							170									
S	8	100 00 400	N	100 04 300	F	4	600	20	20						60	P5, P6								
S	9	102 01 946	N	105 10 021	S	2	1000	40							170	P4								
S	9	100 10 211	S	100 12 600	I	2	1000	20							50									
S	10	200 24 057	N	100 20 050	F																			
G	11	203 04 043	N	107 04 704	E																			
S	12	103 10 207	N	107 02 044	S	4	500	30	10						54									
S	12	100 10 500	N	100 00 400	F	2	1700	10							85									
G	12	502 17 004	N	100 00 000	E																			



Step 7. Check the selection criteria:

- The calendar month: *All the fish were caught in the month of May.*
- The school association: *All the fish have school association 2 (feeding on baitfish).*
- The fishing area: *We have checked the fishing positions below.*

03°35.258 N 163°56.159 E

Latitude: 03° 35.258 N = 03°N has the coordinates 0°–5°N

Longitude: 163°56.159 E = 163°E has the coordinates 160°–165°E

This fishing position is in the 5° x 5° square **0°–5° N; 160°–165° E**

02°58.247 N 163°39.753 E

Latitude: 02°58.247 N = 02°N has the coordinates 0°–5° N

Longitude: 163°39.753 N = 163°N has the coordinates 160°–165° N

This fishing position is in the 5°x 5° square **0°–5° N; 160°–165° E**

03° 18.346 N 163°55.736 E

Latitude: 0318.3 46 N = 03°N has the coordinates 0°–5° N

Longitude: 163°55. 736 E = 163° has the coordinates 160°–165° N

This fishing position is in the 5° x 5° square **0°–5°N; 160°–165°E**

All the fishing positions are in the same 5° x 5° fishing area.

All the fish in the well have the same school association, fishing area, and calendar month, so we can proceed with sampling.



- Step 8.** Transcribe the highlighted lines from logsheets directly onto your port sampling sheet.
Step 9. Fill in the sampling strategy, well number, and well weight.

SET DETAILS (to be obtained from Vessel Logsheets)													
MONTH	DAY	LATITUDE ddmm.mmm	^N E	LONGITUDE dddmm.mmm	^E W	SCHOOL ASSOC.	SET START TIME	SKIPJACK WEIGHT	YELLOWFI N WEIGHT	BIGEYE WEIGHT	OTHER SPECIES NAME	SPECIES WEIGHT	WELL NUMBERS
5	4	03 35.258	N	163 56.159	E	2	830	40	20				P1, S1
5	4	02 58.247	N	163 39.753	E	2	1530	20					S1
5	5	03 18.346	N	163 55.736	E	2	1200	35	10				S3, S1
SAMPLING STRATEGY (very important)										SAMPLED WELL			
Please tick correct	<input checked="" type="checkbox"/>	RANDOM SPECIES - species composition and length frequency sample						R.B. Record all weights in metric tonnes (<u>MT</u>)			WELL NUMBER:		S1
		NON-RANDOM SPECIES - length frequency sample on									WEIGHT OF FISH IN WELL		45



Chapter 9: The Regional Data Collection Forms



